

CRITICOOL[®] OPERATIONAL TRAINING

SOFTWARE VERSION 6.4



CRITICOOL® INDICATION FOR USE



Indication for Use

- CritiCool is a thermal regulating system, indicated for monitoring and controlling patient temperature

CRITICOOL PRODUCT FAMILY





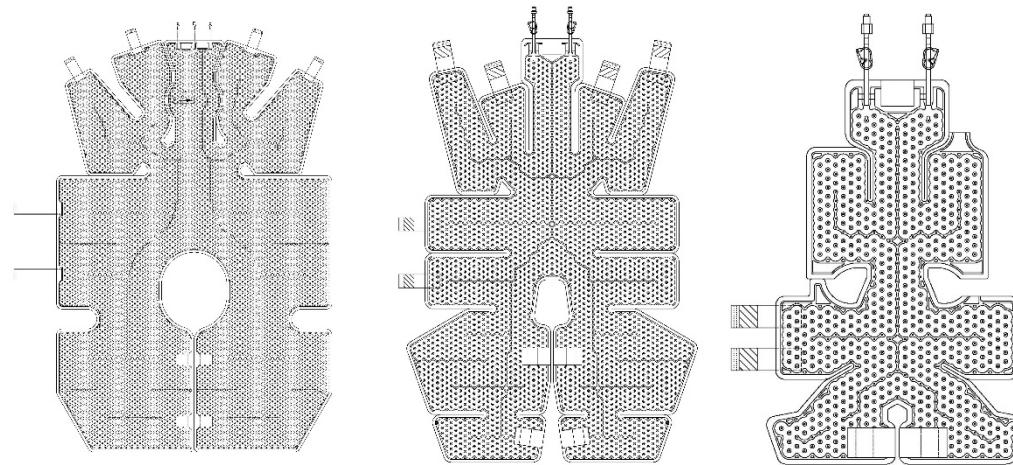

CritiCool® Control Unit



CureWrap® Garments

SIMPLE. PRECISE. EFFECTIVE.

TARGETED TEMPERATURE MANAGEMENT HAS NEVER BEEN EASIER

-  **SET**
Select the desired temperature set point
-  **WRAP**
Apply the CureWrap garment
-  **TTM**
Initiate targeted temperature management mode
-  **REWARM**
Manage controlled rewarming mode



SIMPLE. PRECISE. EFFECTIVE.

Every 133 milliseconds

The control unit reads the patient's core temperature through specific probes every 133 milliseconds and adjusts temperature as necessary in order to maintain the physician determined pre-set temperature settings.

Every 0.133 seconds



Safe, Precise, and Effective

ADVANCED TEMPERATURE MANAGEMENT

- Precise temperature control as set by the physician
- Full-color, touch-screen display
- Simple, easy to use interface with intuitive controls
- Real-time monitoring and graphical display of temperature measurements
- Quick and easy set up
- Track data using the CliniLogger™



SIMPLE, EASY TO USE INTERFACE

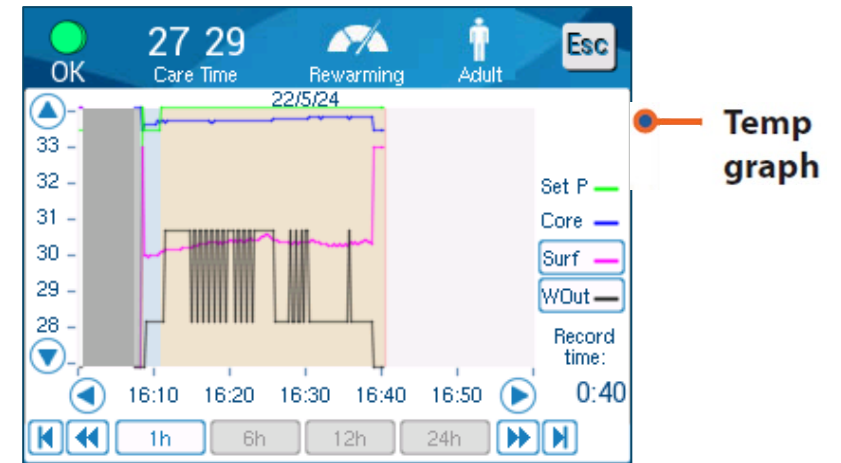
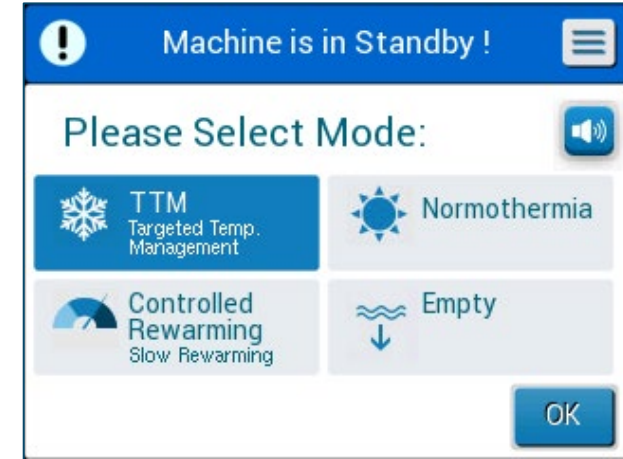
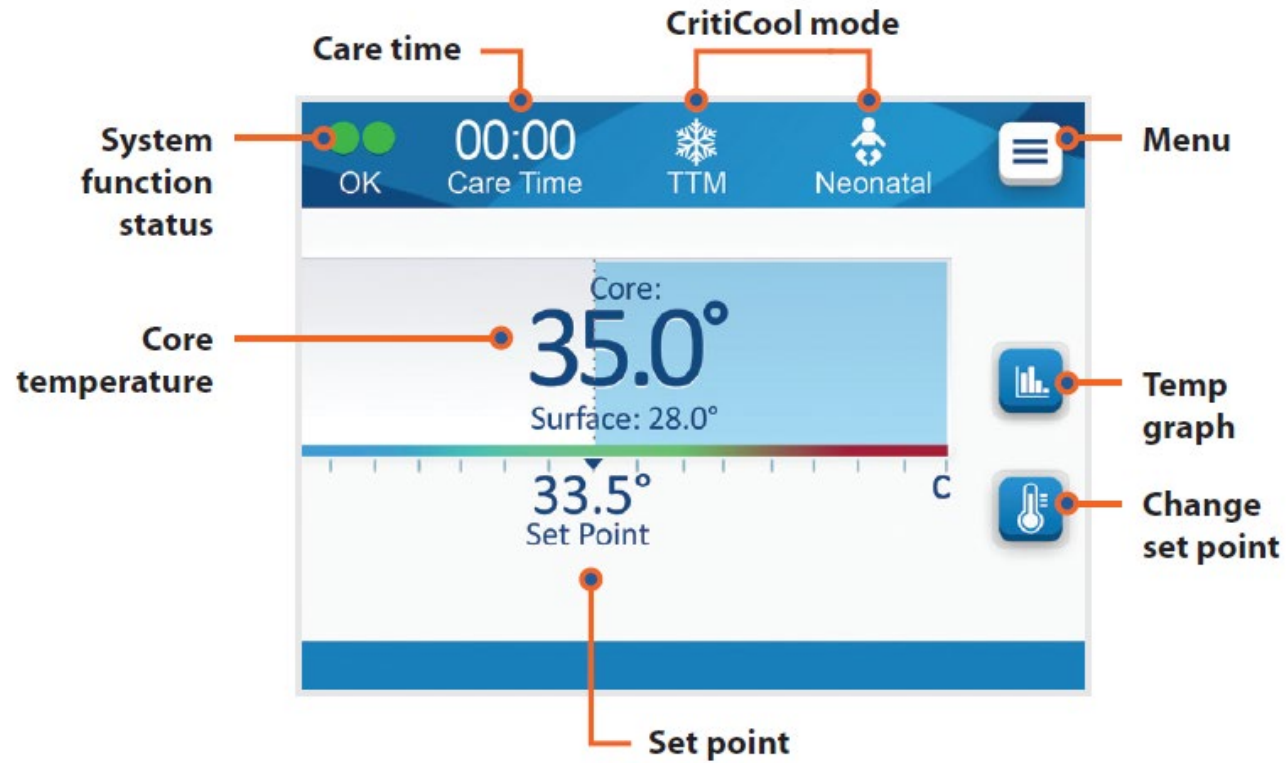

CRITICOOL CONTROL UNIT: FRONT VIEW

Color Touch Screen

Soft bottom keys

Surface sensor socket

Core sensor socket

Water in coupling connector

Water out coupling connector

Water level indicator



CRITICOOL CONTROL UNIT: REAR VIEW

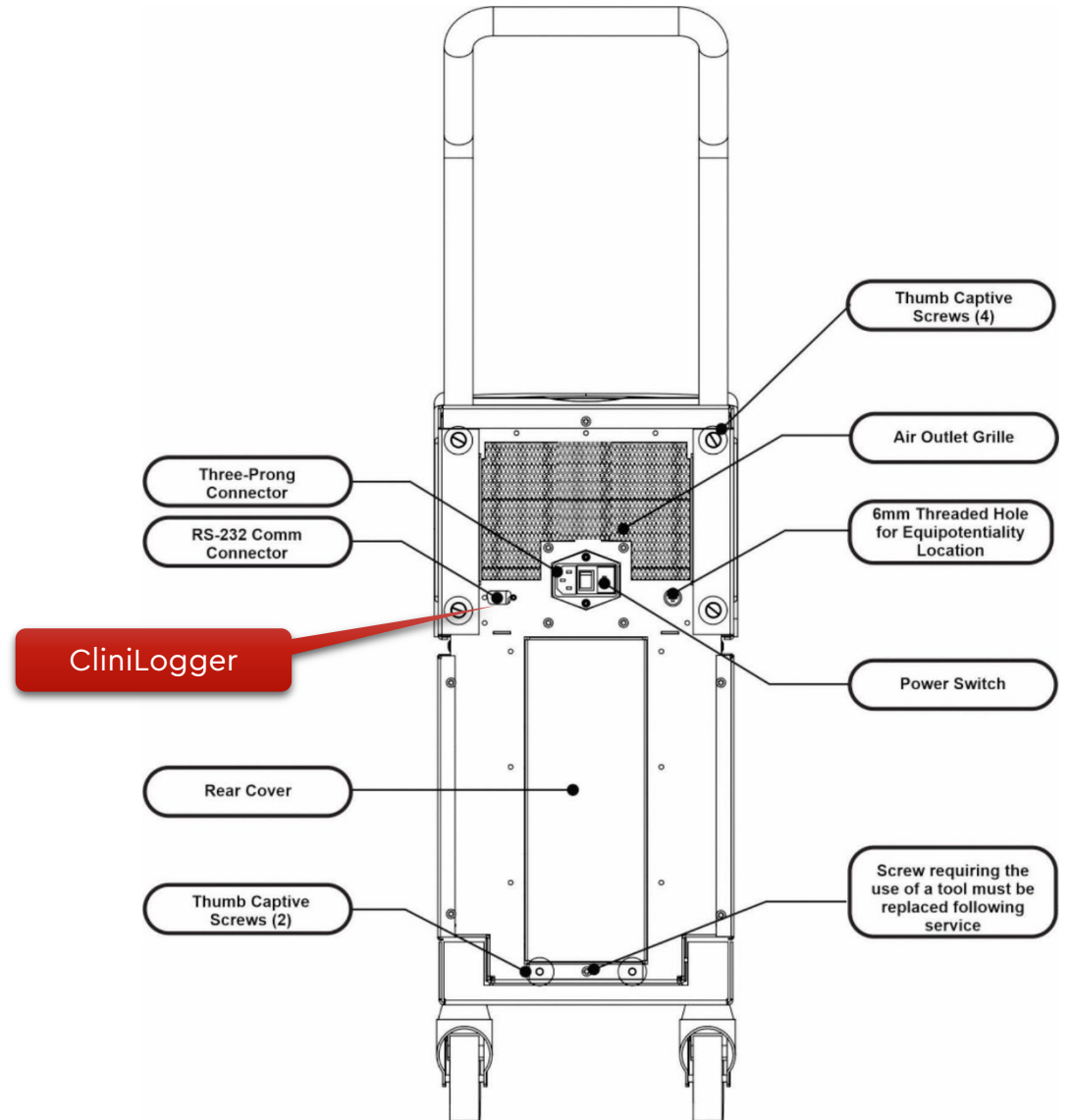
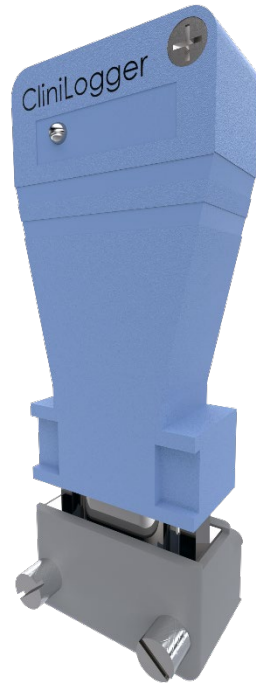

CUREWRAP – BOX CONFIGURATIONS

	Type	Part Number	Number of Wraps per Package	Patient Height / Weight	Wrap Length / Width (m)
Single Size	Adult	508-03500	8	Over 135 cm (Over 53")	2.030/1.354
	Infant	508-03518	8	2.5 to 4 kg (5.5 to 8.8 lb)	0.659/0.448
		508-03521	8	4-7 kg (8.8-15.5 lb)	0.698/0.602
Pediatric Assortments	Pediatric (Small/Infant)	PED-SM008	8 (multi-size)	2.5 to 4 kg (5.5 to 8.8 lb) 4-7 kg (8.8-15.5 lb)	0.659/0.448 0.698/0.602
	Pediatric (Medium)	PED-MD008	8 (multi-size)	7-11 kg (15.5-24.3 lb) 79-91 cm (31-36")	0.981/0.628 1.118/0.740
	Pediatric (Large)	PED-LA008	8 (multi-size)	91-104 cm (36-41") 104-122 cm (41-48")	1.225/ 0.841 1.390/1.054
	Pediatric (X-Large)	PED-XL008	8 (multi-size)	122-135 cm (48-53") Over 135 cm (Over 53")	1.582/1.119 2.030 /1.354

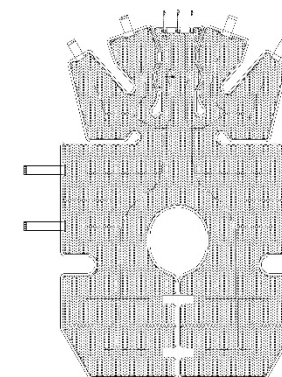

Adult

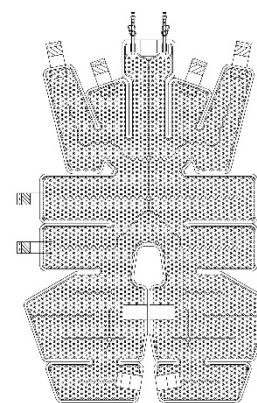

Pediatric

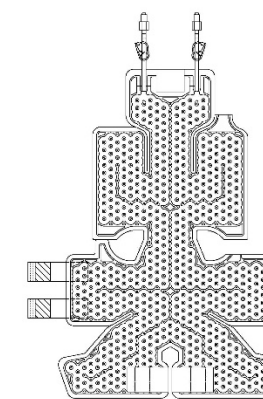

Infant





SETTING UP CRITICOOL

UNPACKING CRITICOOL

Upon arrival, check the SHOCKWATCH® and TIP-N-TELL® indicators.

If either has been activated, immediately open the package and check for external damage. If the device has been damaged, photograph the damage and immediately notify the shipping carrier and/or Belmont Medical Technologies at techservice@belmontmedtech.com, being sure to provide all relevant information, including evidence of the damage.

1

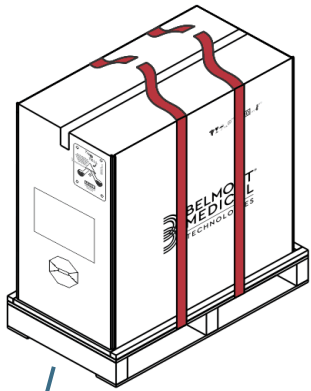

Accessory Kit includes reusable accessories (ie. Hoses & cables) and one CritiCool disinfection kit.

2

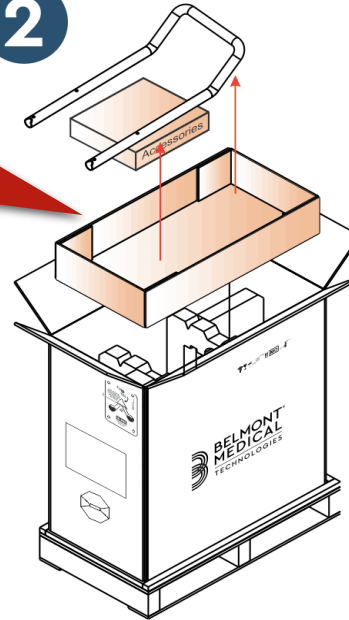

3

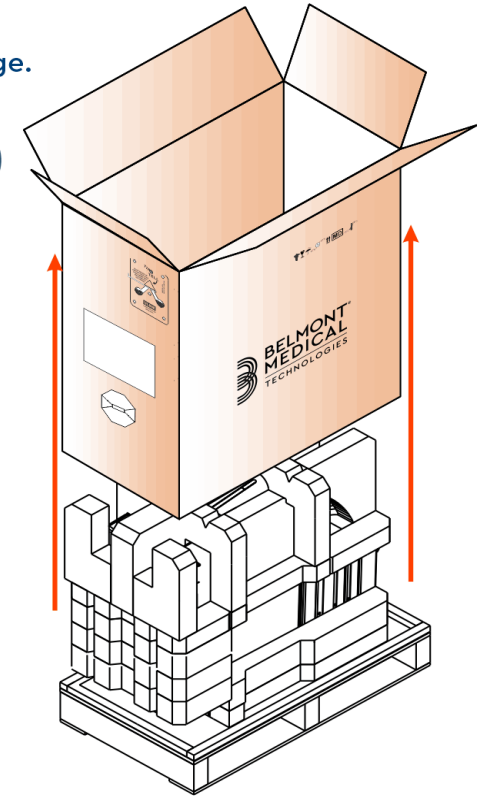

Unpacking instructions are affixed to the box. Please refer to instructions on the box.

Keep the original box

UNPACKING CRITICOOL

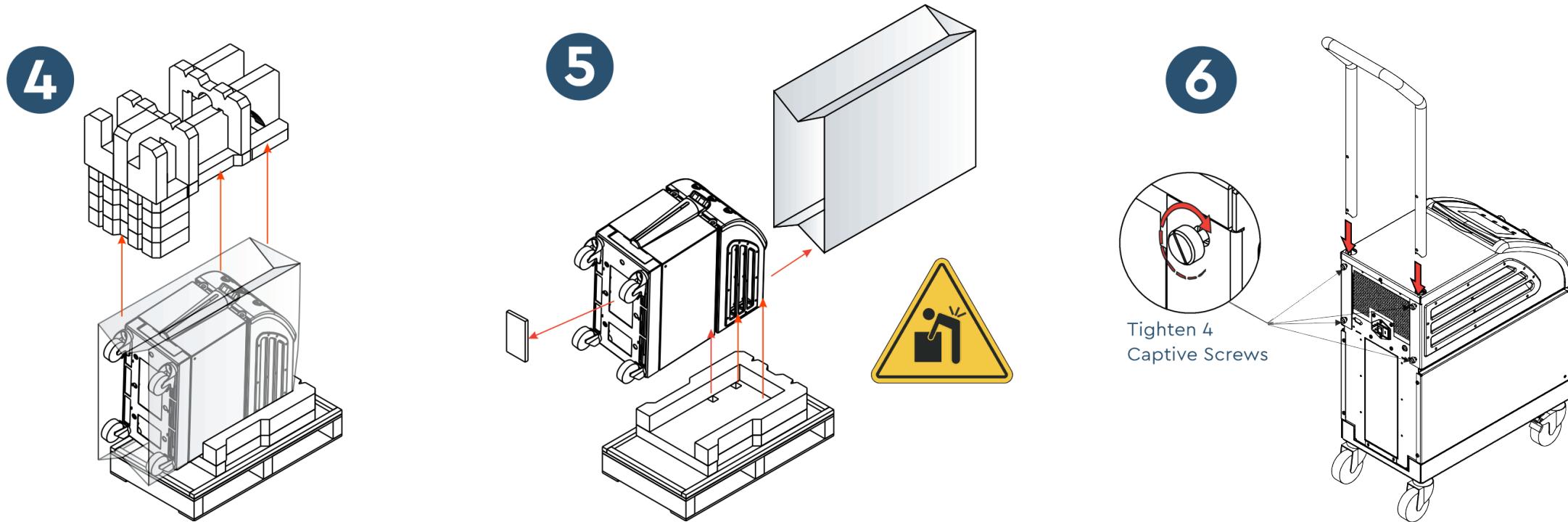

Note: If using CliniLogger, secure to the serial port on the rear of the device.



SETTING UP CRITICOOL

1. Fill tank with sterile water or 0.22 micron filtered water
 - The largest CureWrap 500-03500 requires 6L (up to the red line on the water level indicator).
 - Smaller CureWraps will need less water.
2. Place the CritiCool unit near the bed and lock the front wheels
3. Power **ON** switch - after a short Self Test, Mode Select screen appears

NOTE: CritiCool cools the water once powered on, as lowering a patient's temperature requires colder water.

If the intention is to achieve or maintain normothermia, before powering on, connect hoses, wrap, and probes, then swiftly power on, initiate the operation mode and ensure set point is appropriate.

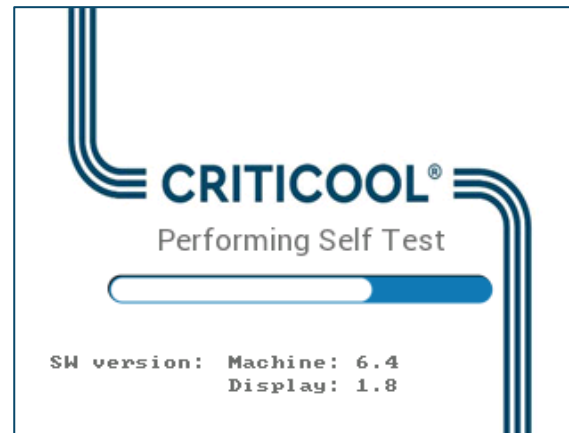

SELECTING A CUREWRAP

1. Choose an appropriately sized CureWrap
 - Wrap should be loose



Type	Part Number	Patient Height / Weight	Wrap Length / Width (m)
Infant / Pediatric (Small)	500-03518	2.5 to 4 kg (5.5 to 8.8 lb)	0.659/0.448
	500-03521	4-7 kg (8.8-15.5 lb)	0.698/0.602
Pediatric (Medium)	500-03525	7-11 kg (15.5-24.3 lb)	0.981/0.628
	500-03531	79-91 cm (31-36")	1.118/0.740
Pediatric (Large)	500-03536	91-104 cm (36-41")	1.225/ 0.841
	500-03541	104-122 cm (41-48")	1.390/1.054
Pediatric (X-Large)	500-03548	122-135 cm (48-53")	1.582/1.119
Adult / Pediatric (X-Large)	500-03500	Over 135 cm (Over 53")	2.030/1.354

NOTE: Part Numbers shown above and circled left are for single wraps. CureWrap is sold in boxes of 8; see [slide 10](#).

SETTING UP CUREWRAP

1. Place the appropriate CureWrap on the bed or underneath patient

- Tubes go at the head of the bed
- The side with a more apparent wrap pattern and more texture should be face up
- See CureWrap Instructions For Use

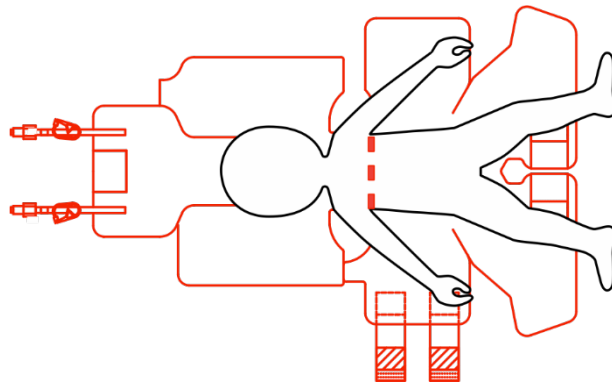
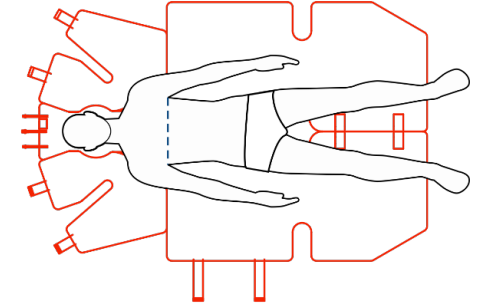
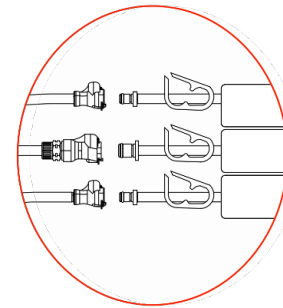
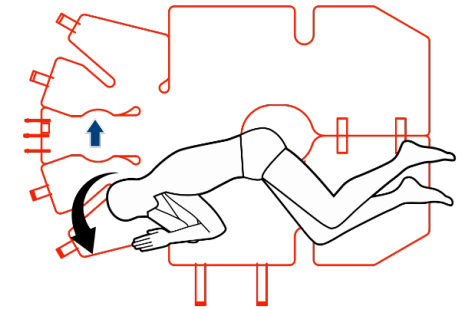
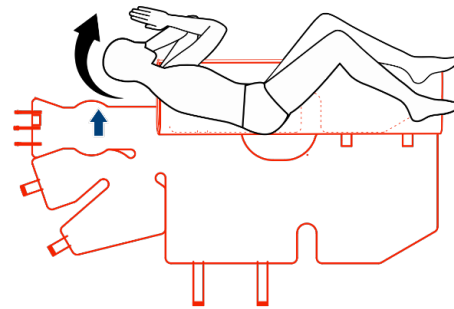
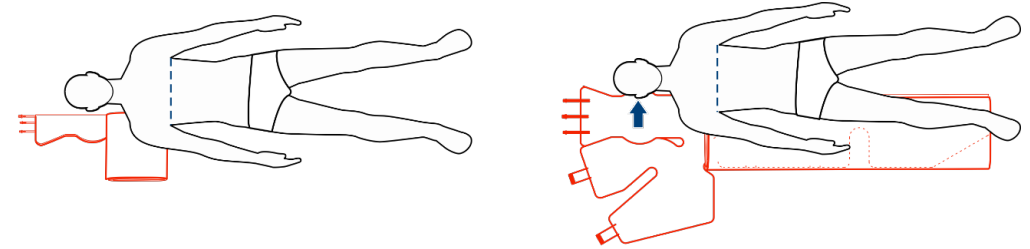

SELECTING TEMPERATURE PROBE TYPE

Reusable Temperature Probes

Disposable Temperature Probes

Core

PN# 014-00005

PN# 014-00020



Infant 10FR

OR

Adult 12FR

PN# 014-00035

PN# 014-00038

PN# 014-00036

PN# 014-00220



PN# 014-00028



Disposable

AND

Adapter Cable

Surface

PN# 014-00021



PN# 014-00323

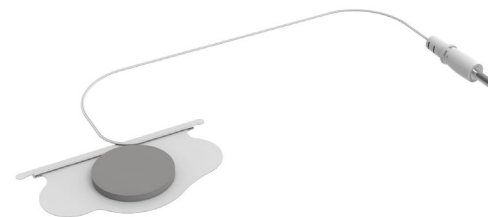

PN# 014-00324

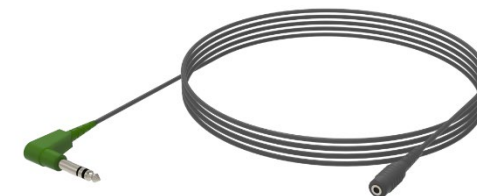

Disposable

AND

Adapter Cable



USING REUSABLE PROBES

- Connect **Core** probe to the **Core** socket and **Surface** probe to the **Surface** socket

SURFACE on left
Green color coding

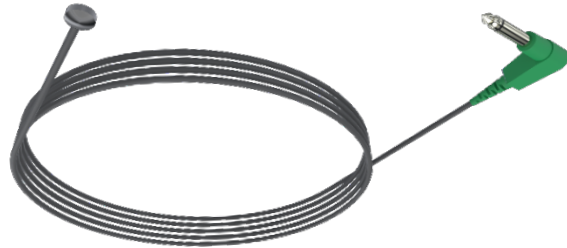

CORE on right
Gray color coding



Note: Reusable probes are only available in select markets.

DISPOSABLE PROBES – ADAPTER CABLE SET UP

For use with Disposable Probes:

1. Connect **Core** cable to the **Core** socket and **Surface** cable to the **Surface** socket

SURFACE on left
Green color coding

CORE on right
Gray color coding

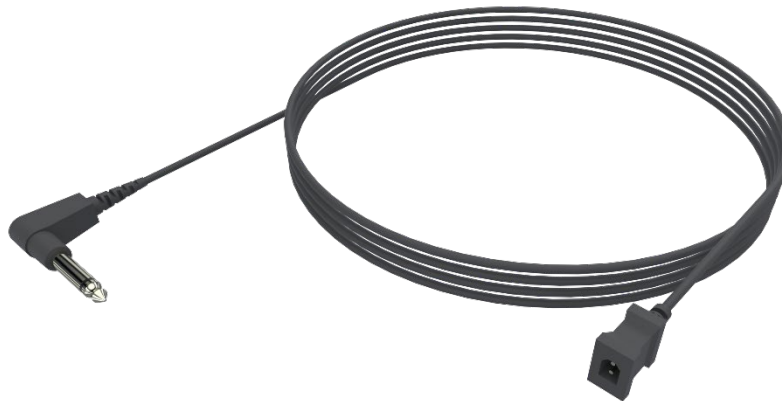
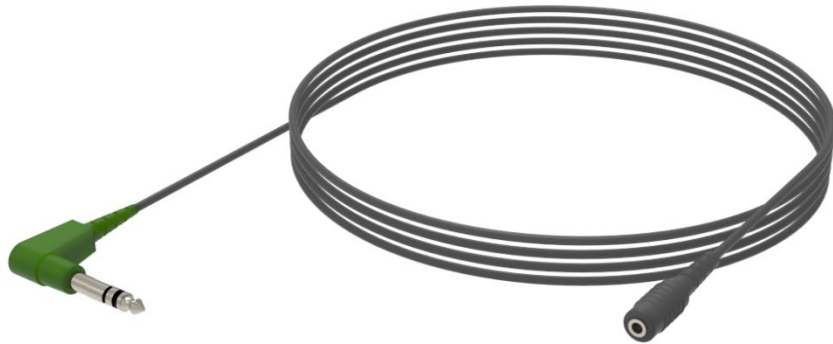

Cables shown above are representative only.

DISPOSABLE PROBES – PROBE SET UP

1. Connect Core sensor to the Core Adapter Cable and the Surface sensor to the Surface Adapter Cable

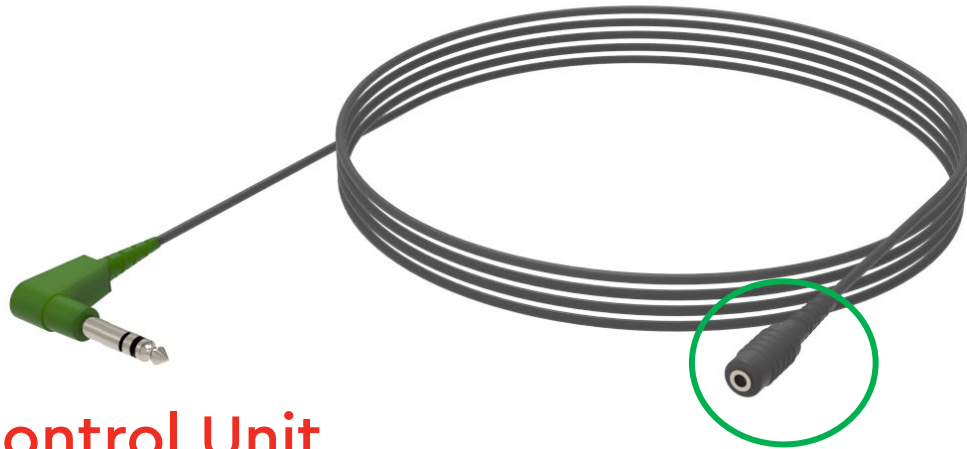

Control Unit

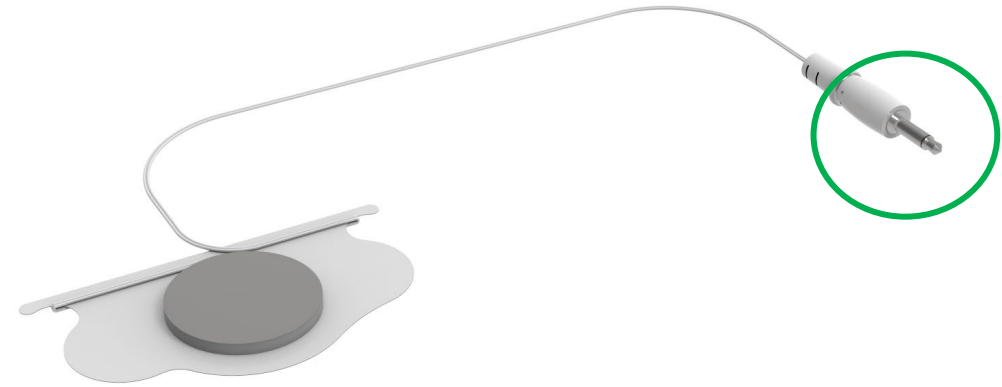

Patient

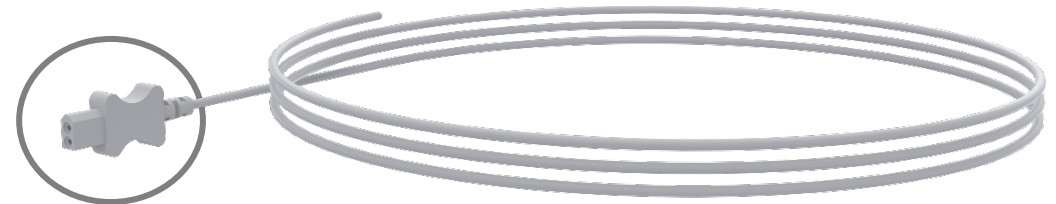

TEMPERATURE PROBES – PATIENT SET UP

1. Insert Core sensors into the patient and position the Surface sensor on the patient skin

- **Core Probe Placement:**

- Rectal/esophageal
- PN# 014-00035, 014-00036, 014-00038 or 014-00220

- **Surface Probe Placement:**

- Do not place skin sensor under the CureWrap
- Neonates: often by clavicle
- PN# 014-00323

Please review all indications and contraindications for each probe prior to use.

Refer to Probe Sales Eligibility by Market 701-00491, 701-00492 and 701-00565 to determine where items may be sold.

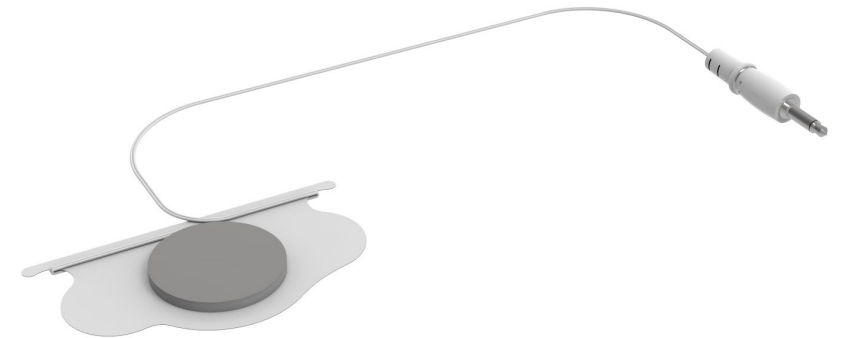

NOTE ABOUT CONNECTING CORE PROBE

- CritiCool cannot thermoregulate without a valid Core readout
 - Therefore, water will not flow into CureWrap until the core probe is connected to CritiCool and the core probe is attached to the patient.

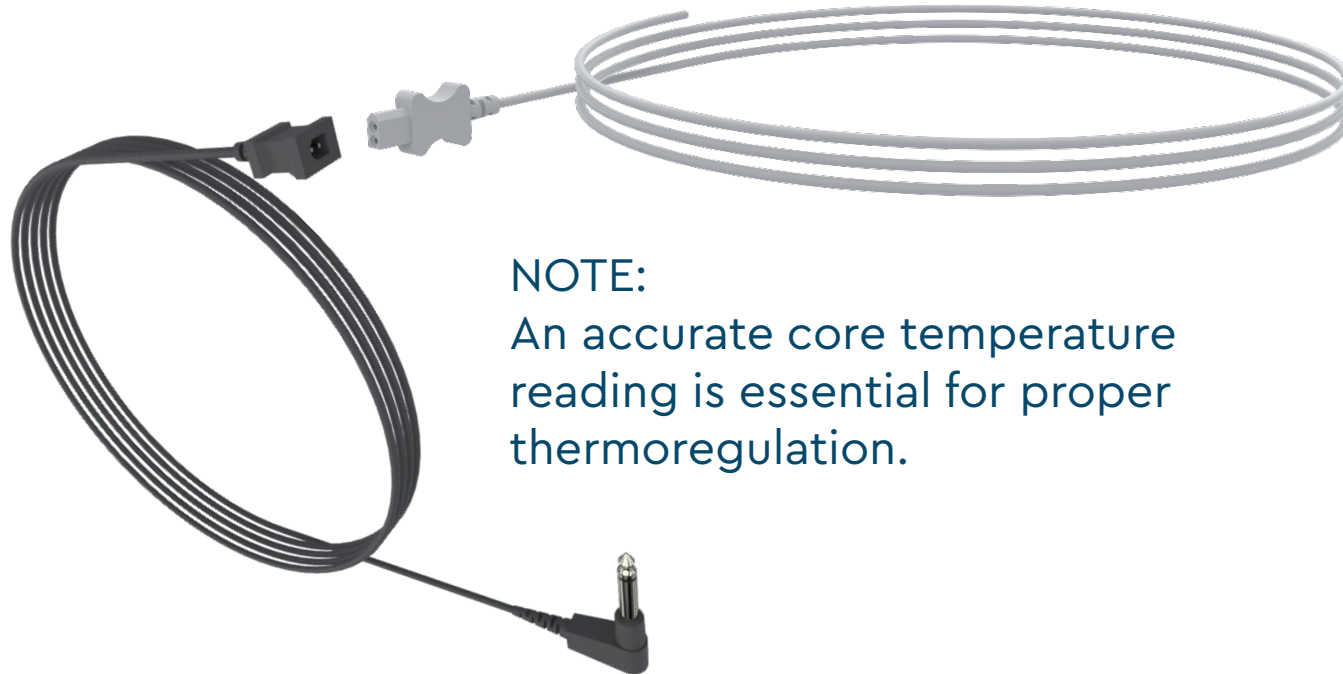

NOTE:
An accurate core temperature reading is essential for proper thermoregulation.



SETTING UP CRITICOOL – CONNECT HOSES

1. Connect metal fittings on blue hose to metal fittings on the front of CritiCool
 - Listen for a click
 - Tug slightly to ensure securely inserted



SETTING UP CRITICOOL – CONNECT CUREWRAP

1. Connect plastic ends of blue connecting water hoses to wrap.

- Listen for a click
- Wrap should be filled with water prior to wrapping patient
- Ensure clamps are OPEN

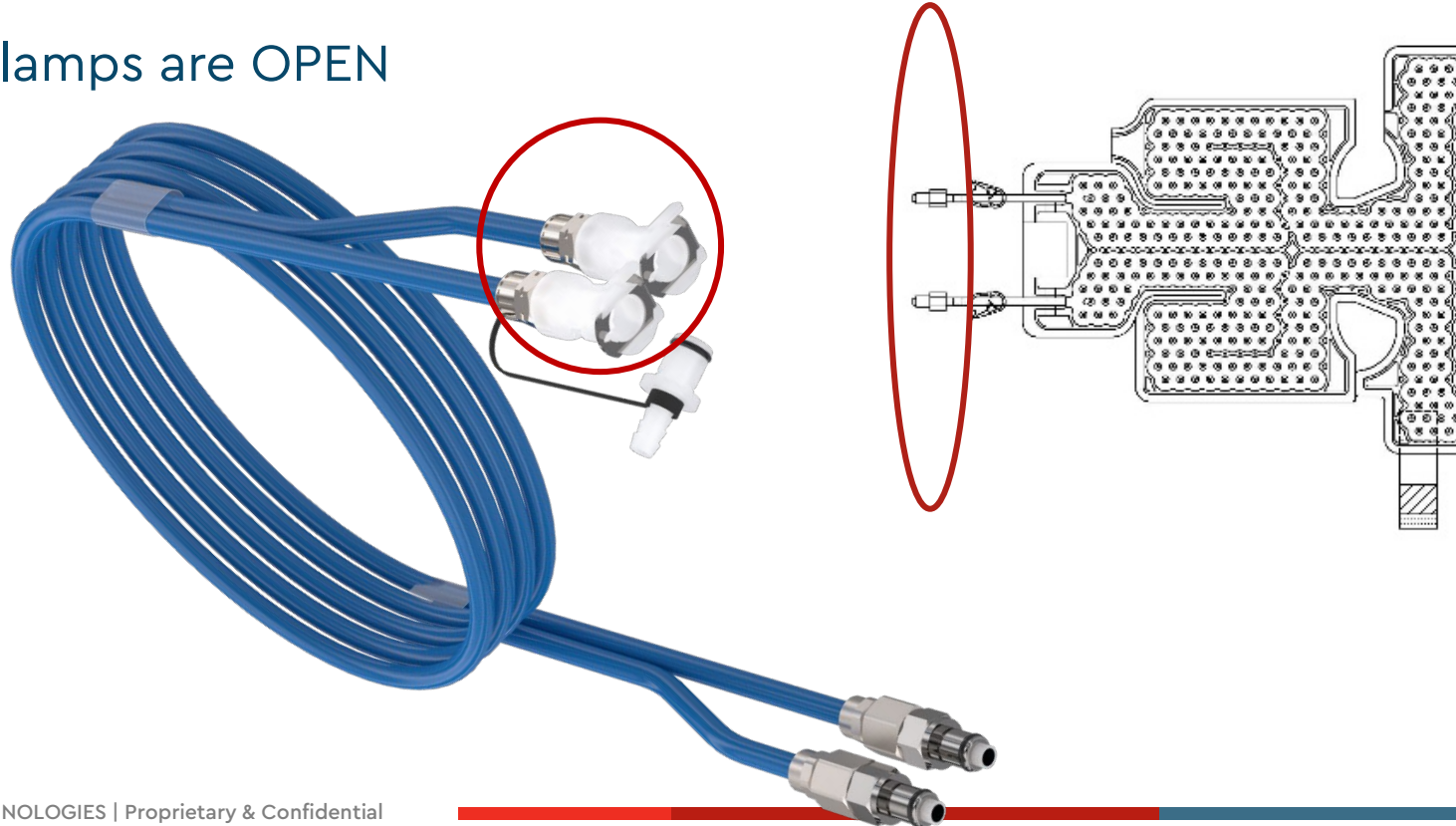

HOSES NEEDED FOR EACH CUREWRAP (BOXES SHOWN)

	Type	Part Number	Number of Wraps per Package	Patient Height / Weight	Wrap Length / Width (m)
Single Size	Adult	508-03500	8	Over 135 cm (Over 53")	2.030/1.354
	Infant	508-03518	8	2.5 to 4 kg (5.5 to 8.8 lb)	0.659/0.448
		508-03521	8	4-7 kg (8.8-15.5 lb)	0.698/0.602
Pediatric Assortments	Pediatric (Small)	PED-SM008	8 (multi-size)	2.5 to 4 kg (5.5 to 8.8 lb)	0.659/0.448
	4-7 kg (8.8-15.5 lb)			0.698/0.602	
	Pediatric (Medium)	PED-MD008	8 (multi-size)	7-11 kg (15.5-24.3 lb) 79-91 cm (31-36")	0.981/0.628 1.118/0.740
	Pediatric (Large)	PED-LA008	8 (multi-size)	91-104 cm (36-41") 104-122 cm (41-48")	1.225/ 0.841 1.390/1.054
	Pediatric (X-Large)	PED-XL008	8 (multi-size)	122-135 cm (48-53") Over 135 cm (Over 53")	1.582/1.119 2.030 /1.354

Uses 2x3 Way Connecting Water Hoses: 200-00147



Uses 2x2 Way Connecting Water Hoses: 200-00109

Uses 2x3 Way Connecting Water Hoses: 200-00147



IF USING CUREWRAP 500-03500 (ADULT/PEDIATRIC XL):

Use the 2x3 Way Water Connecting Tubes

- The 2x3 way Connecting Water Hoses (200-00147) are needed for 500-03500
- 500-03500 is sold in two different boxes of CureWraps:
 - 508-03500 (includes eight 500-03500 CureWraps)
 - PED-XL008 (includes four 500-03500 and four 500-03548 CureWraps)
- 500-03500 has 3 connectors to the CureWrap, one inflow and two return water connections.
- The 2x3 Way Hoses are included in all Adult Accessory Kits or can be ordered separately.

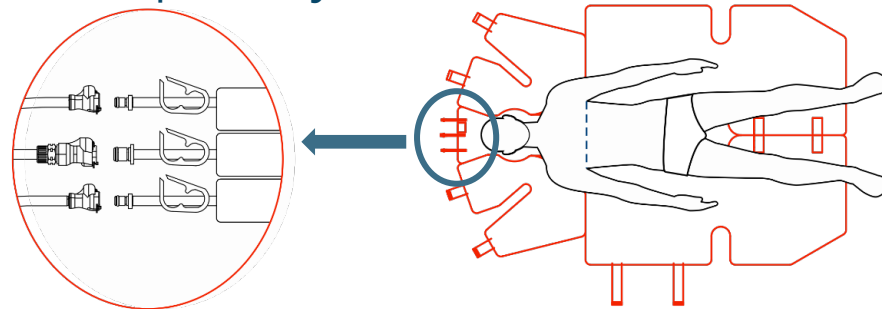

IF USING A CUREWRAP OTHER THAN 500-03500:

Use the 2x2 Way Water Connecting Tubes

- The 2x2 way Connecting Water Hoses (200-00109) are needed for all wraps other than 500-03500.
- All wraps except 500-03500 have 2 connectors to the CureWrap, one for inflow and one for outflow.
- The 2x2 Way hoses are included in all Infant Accessory Kits or can be ordered separately.

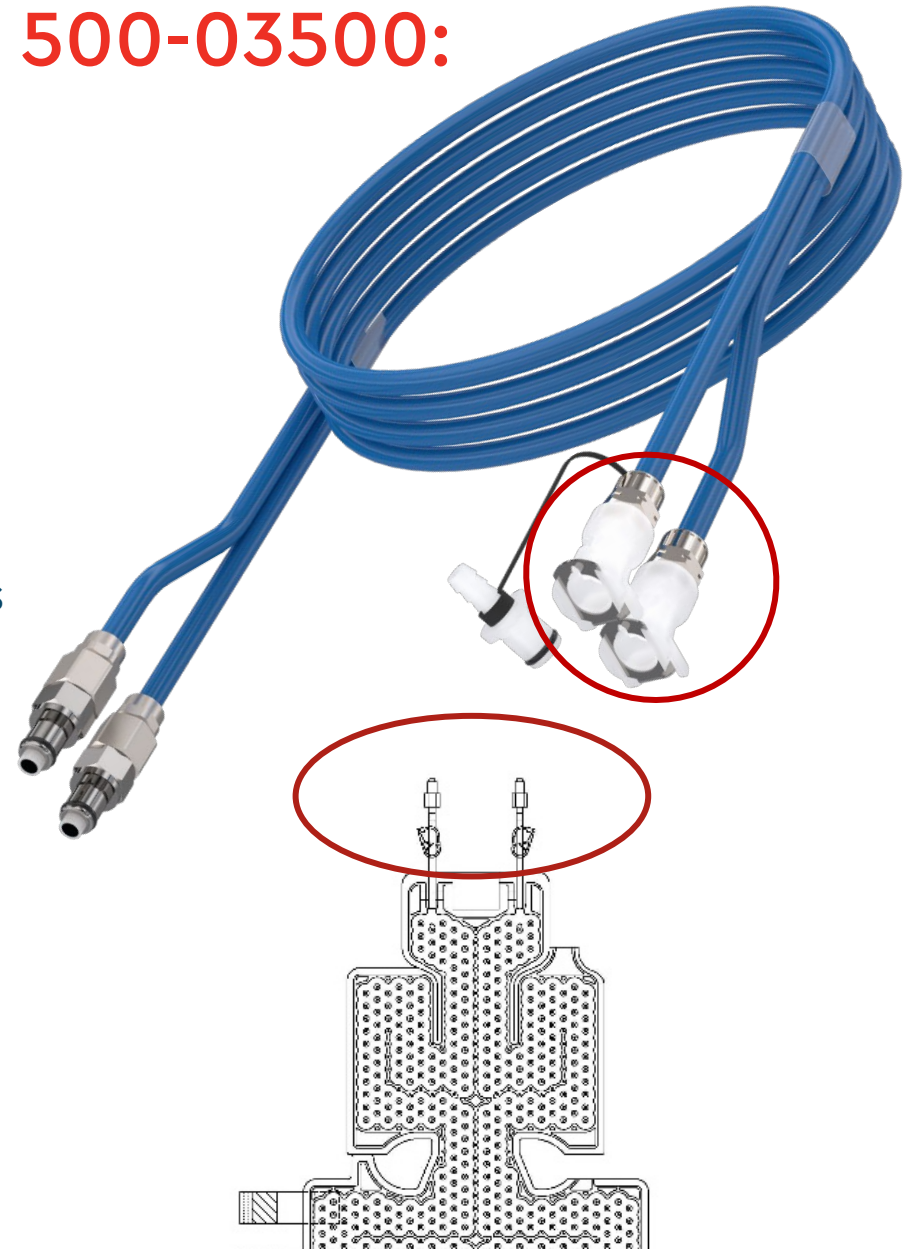

SETTING UP CRITICOOL – TTM MODE

1. After self test is complete, the start up Mode Select screen appears.
2. CritiCool is now cooling and circulating the water internally
3. Push **OK** to select **TTM** mode (default Mode)

NOTE: While the Select Mode Startup Screen is displayed, water is being cooled.

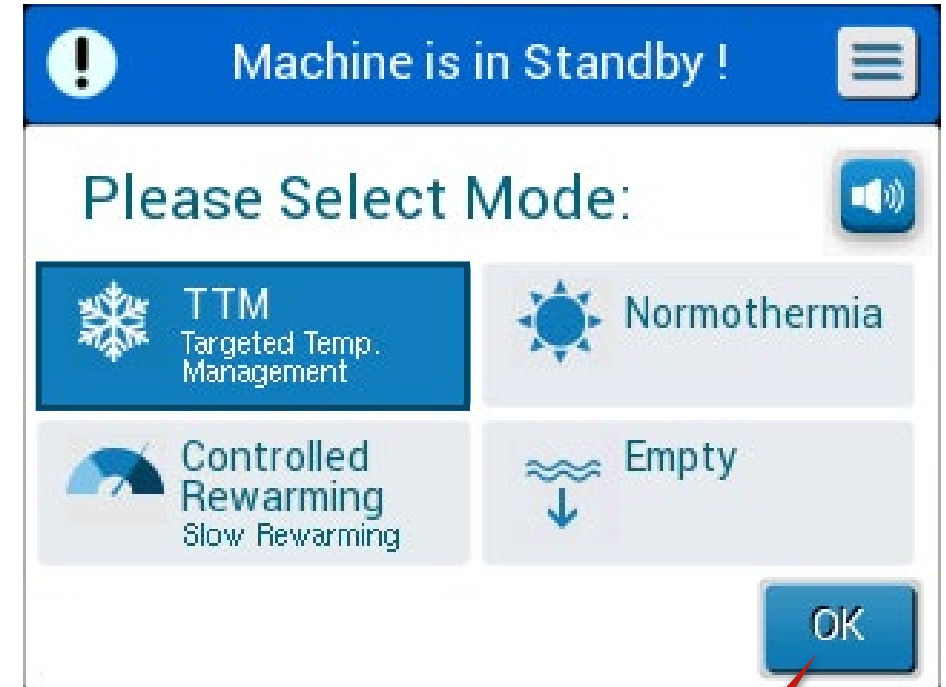

Touch OK to start TTM

SELECTING SET POINT TEMPERATURE

Set Point = Patient's Target Temperature

- The CritiCool cools/warms the patient to reach and maintain the preset **Set Point**
- **TTM Mode Default Set Point:**
 - **33.0°C** for Adult Mode
 - **33.5°C** for Neonatal Mode
- When initiating a mode, always confirm the set point temperature is appropriate and adjust as needed.
- To change the Set Point:
 1. Touch the Set Point Icon/button
 2. Use +/- to select the desired **Set Point**
 3. Press **OK** to confirm



Note: The Default Set Point temperature for Adult Mode can be adjusted in Settings

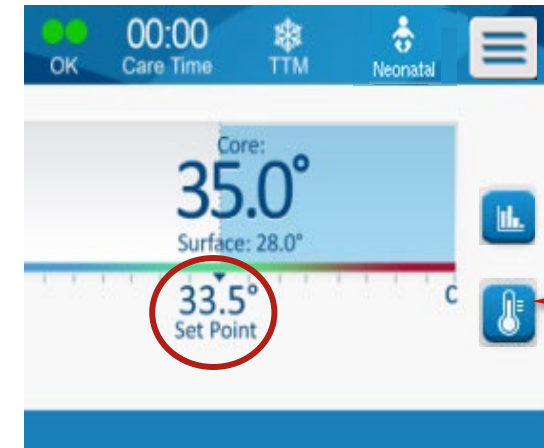

Adjust Set Point

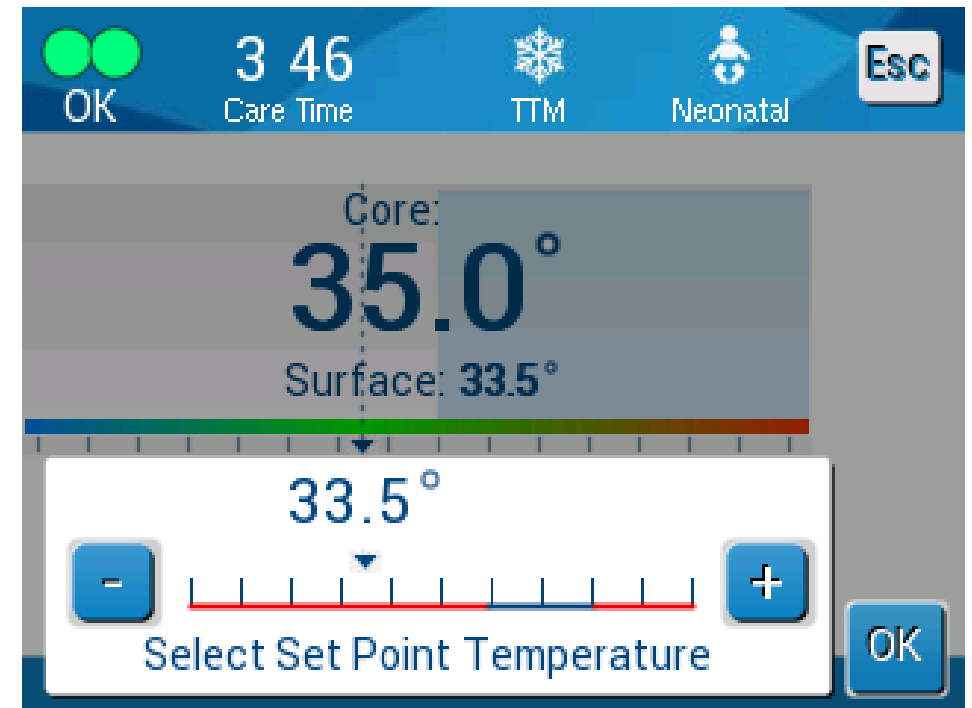

SECURING CUREWRAP AROUND THE PATIENT

1. Confirm that CureWrap is filled with water
2. Secure CureWrap on the patient (see CureWrap Instructions For Use)

Note:

- Ensure clamps to the wrap are open
- Ensure CureWrap fits loosely; there should be a finger's width space
- Do not use the CureWrap to lift the patient
- Avoid handling the CureWrap with sharp objects
- Patient should not be swaddled
- Patient's head should not be wrapped
- Prevent any thermal isolation, such as a pillow or other items, between the wrap and the patient's body
- Constant clicking sound may indicate water obstruction
 - Check to ensure the clamps are open and water is allowed to flow to CureWrap and that water is flowing



SECURING CUREWRAP AROUND THE PATIENT



SECURING CUREWRAP AROUND AN ADULT PATIENT

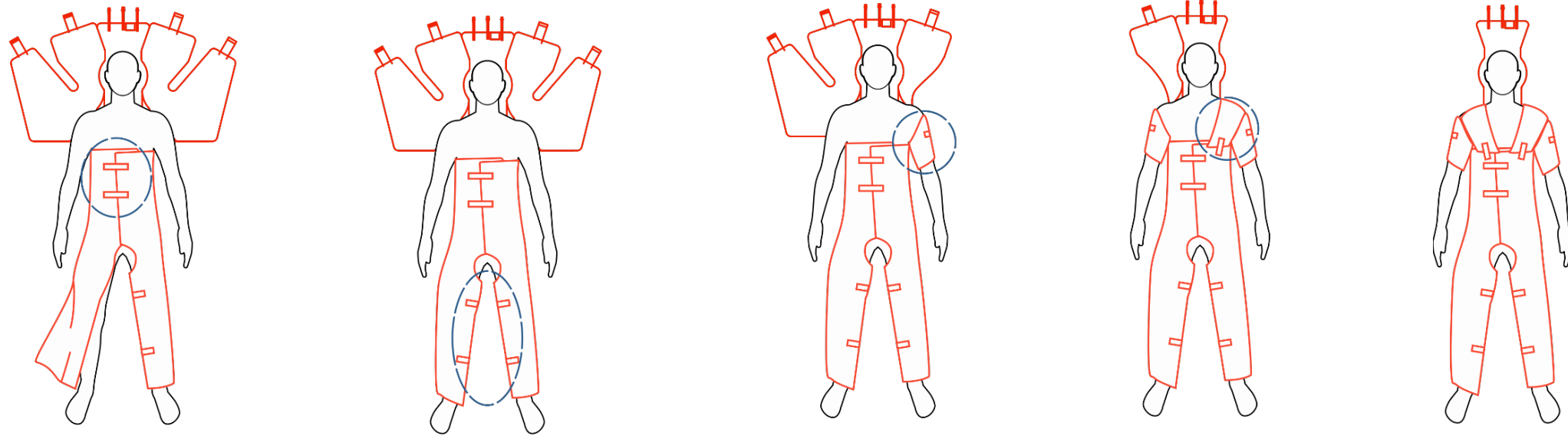

Model 500-03500 CureWrap shown



MAIN OPERATION SCREEN

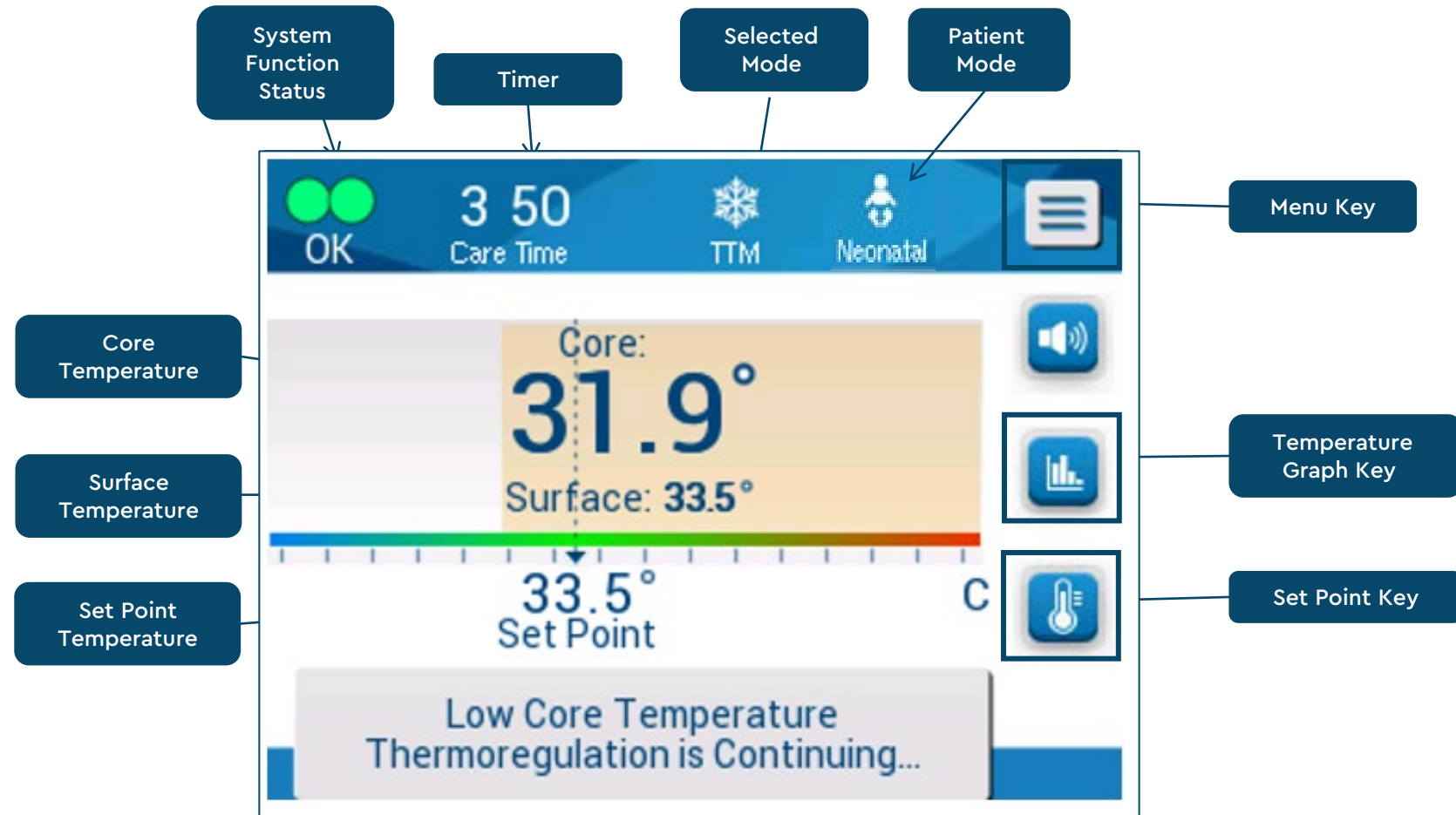

CRITICOOL TOUCHSCREEN

Touch Keys

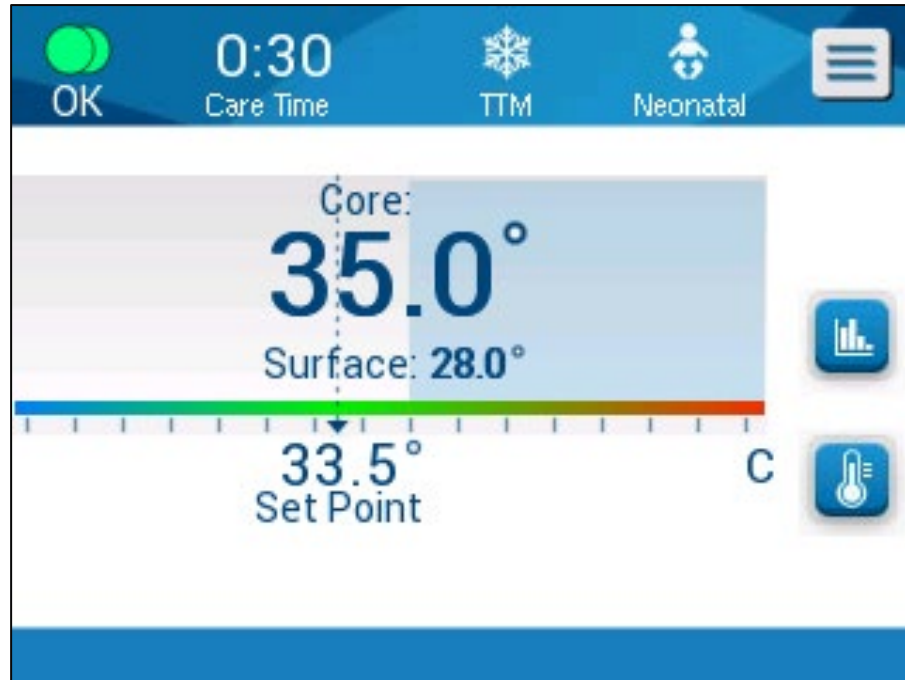

- 5.7" large operational touch-screen
- 5 soft keys
- Power soft key

Soft Button Keys



Main Menu / Escape



Alarm Tone ON/OFF



Show Graph / Up Arrow



Open Settings Panel / Down Arrow



Accept Changes

MENU OPTIONS

Touch the **Menu Icon** / **Soft Button Key**



Drop Menu will appear with the following options:



← Once the Menu drop down ESC icon appears, touch it to return to previous screen

TEMPERATURE GRAPH

- Use the Temp Graph icon / soft key to enter a Graphic Display of the current or last case temperature data
- CritiCool displays the current case temperature data:
 - Set P (Set Point Temperature)
 - Core (Core Temperature)
 - Surf (Surface Temperature)
 - WOut (Water Out Temperature)
- 1 hour, 6 hours, 12 hours and 24 hours displays are available
- Last case data is saved until next patient is connected
- Press **ESC** to return to main screen

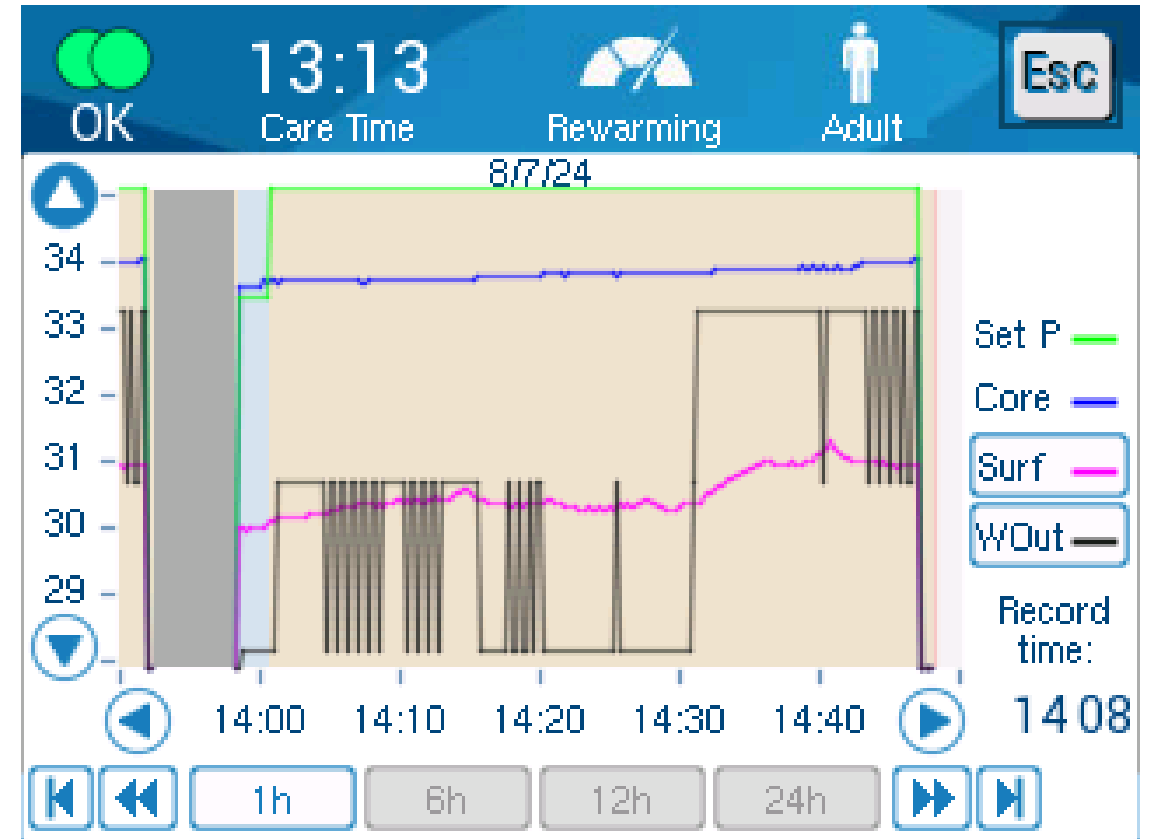

SETTINGS SCREEN – PASSWORD PROTECTED

- Password for the Settings Screen: 6873

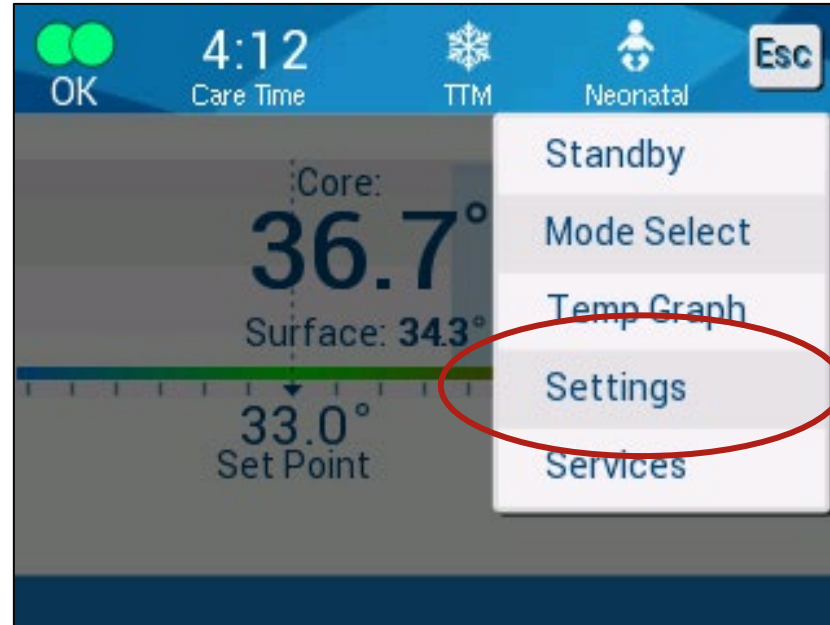
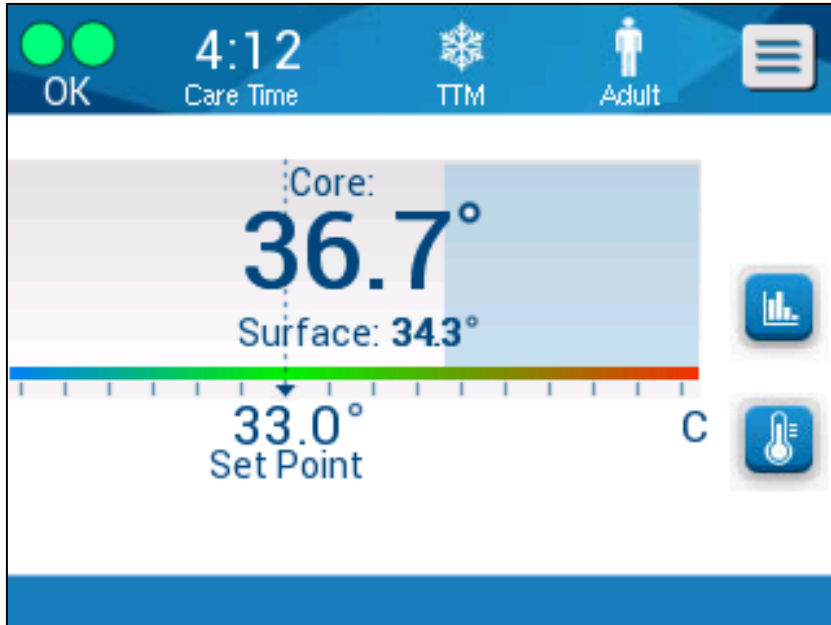

SETTINGS SCREEN – PASSWORD PROTECTED

- There are **Four** Screens in the Settings mode
- Push **OK** to confirm and return to main screen
- The CritiCool keeps the last setting to the next power up
 - The default/last selection is highlighted

Screen #1 – General Settings

0 00 Care Time TTM Adult Esc

Patient: Neonatal Adult Language: EN SV

Adult Default SP: 33.0 34.0 35.0 36.0 C Degrees: C F

Rewarming Step: 0.05 0.1 0.15 0.2 0.25 0.3 0.4 0.5 C/hr

1 2 3 OK

Screen #2 – Setting Alarm Limits

OK 4 16 Care Time TTM Adult Esc

Adjustable Alarm Limits

High Patient Temperature 1 C
36.0 36.5 37.0 37.5 38.0 38.5

Low Patient Temperature 2 C
31.0 32.0 33.0 34.0 35.0 36.0

High Water Temperature 3 C
36.0 37.0 38.0 39.0 40.0 41.0 42.0

1 2 3 OK

SETTINGS SCREEN – PASSWORD PROTECTED

Screen #3 – Touch Screen ON/OFF

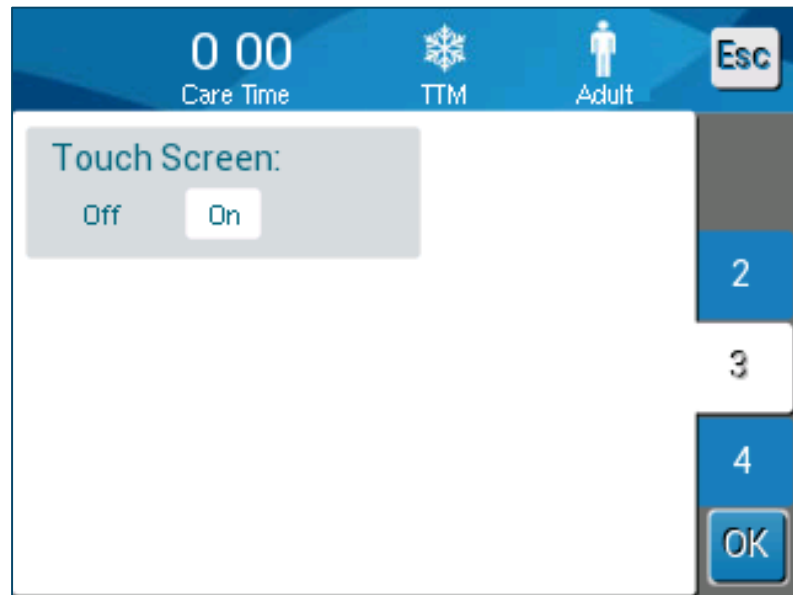

Screen #4 – Set Date and Time

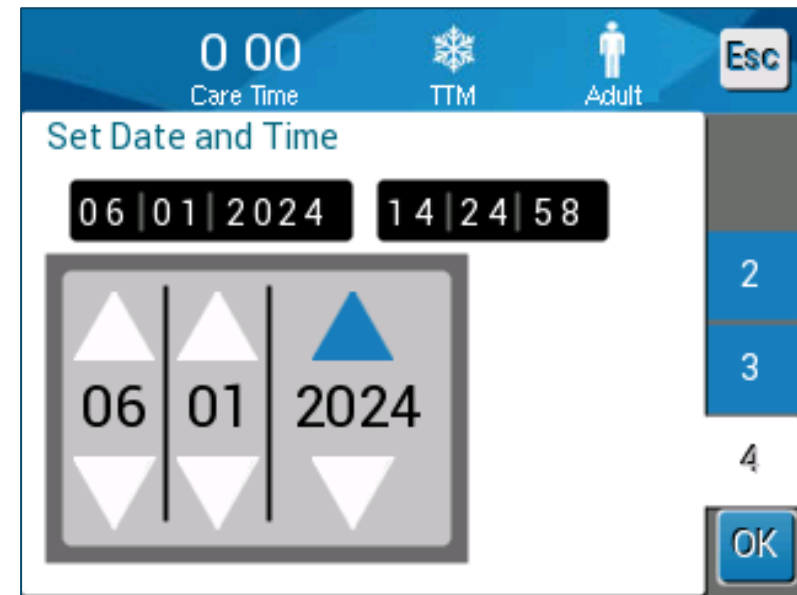

STANDBY MODE

- Turn on Standby mode to stop the water flow to the wrap:
 - End of therapy, before disconnecting the CureWrap
- **Note:** While in Standby Mode, the water temperature is being maintained. The patient is not being thermoregulated in Standby Mode.

To turn on Standby mode:

1. Touch **MENU** icon/button
2. Select **Standby**
 - Water flow to the CureWrap will stop
 - CureWrap will deflate
 - CritiCool will continue to monitor patient's temperature (as long as core temperature probe remains in place)

To resume thermoregulation:

1. Touch **MENU** icon/button
2. Select **OPERATE**

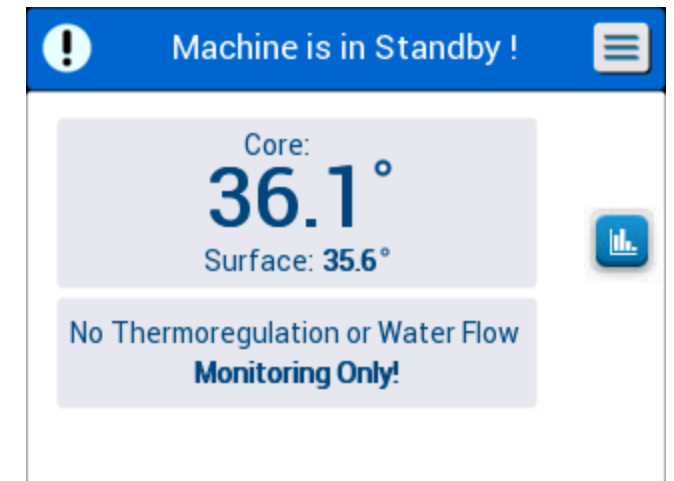

SELECT MODE

Mode Selection:

- **TTM – TARGETED TEMPERATURE MANAGEMENT**
The default mode for body thermoregulation
- **CONTROLLED REWARMING**
Use this mode for slow rewarming
- **NORMOTHERMIA**
Use this mode for Normothermia Management and/or fast warming

To select/change a mode:

1. Touch the **MENU** icon/button
2. Select **MODE SELECT**
3. Touch the desired mode
4. Touch **OK** to confirm

NOTE: When Select Mode screen is displayed, CritiCool maintains the water temperature.

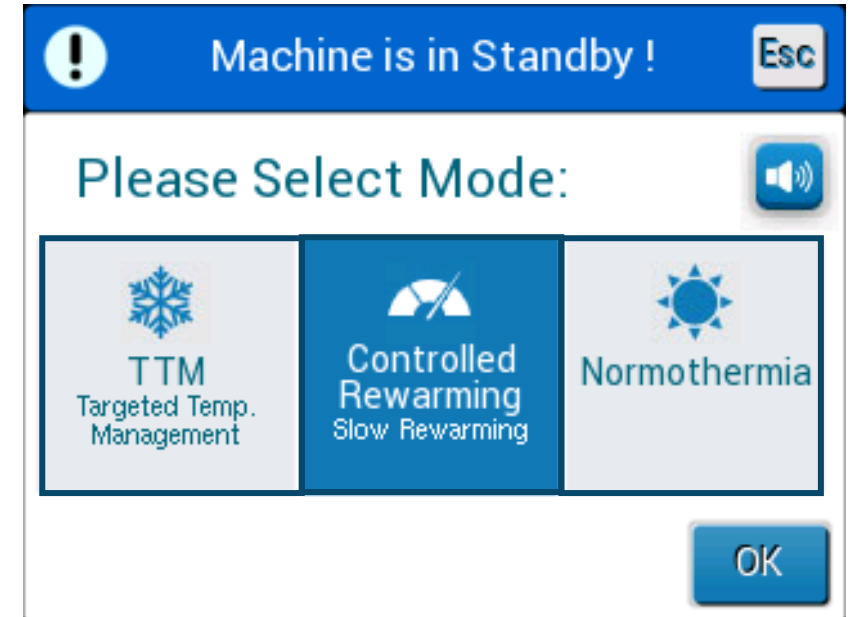

NORMOTHERMIA MODE

- Select Normothermia when normothermia is the goal

- Default Set Point is 37.0°C.

Note:

- Algorithm aims to bring patient to the set point temperature as quickly as possible
 - This mode has **no** rewarming steps
 - This mode features fewer alarms related to low core temperature
 - When using CritiCool to lower patient temperature, it is highly recommended to let the CritiCool® run for 10-15 mins before connecting temperature probes and hoses to allow the water to cool
- The CritiCool warms the patient to reach and maintain the selected **Set Point**
 - When initiating a mode, always confirm the set point temperature is appropriate and adjust as needed.

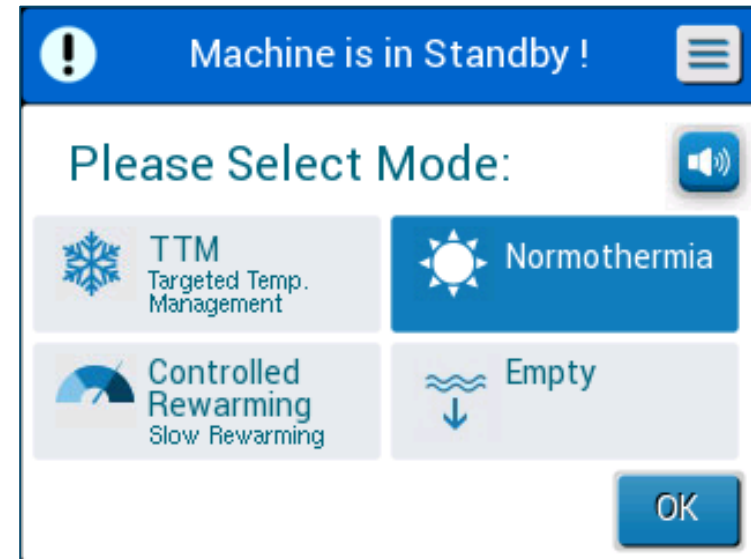

TTM MODE – TARGETED TEMPERATURE MANAGEMENT

TTM – The default mode

- Use this mode:
 - For Targeted Temperature Management
 - To reach a preset set point
 - To maintain patient temperature
 - For manual re-warming
- In TTM mode, the set point temperature will be reached as soon as possible.
- When initiating a mode, always confirm the set point temperature is appropriate and adjust as needed.
- When using CritiCool to lower patient temperature, it is highly recommended to let the CritiCool® run for 10-15 mins before connecting temperature probes and hoses to allow the water to cool

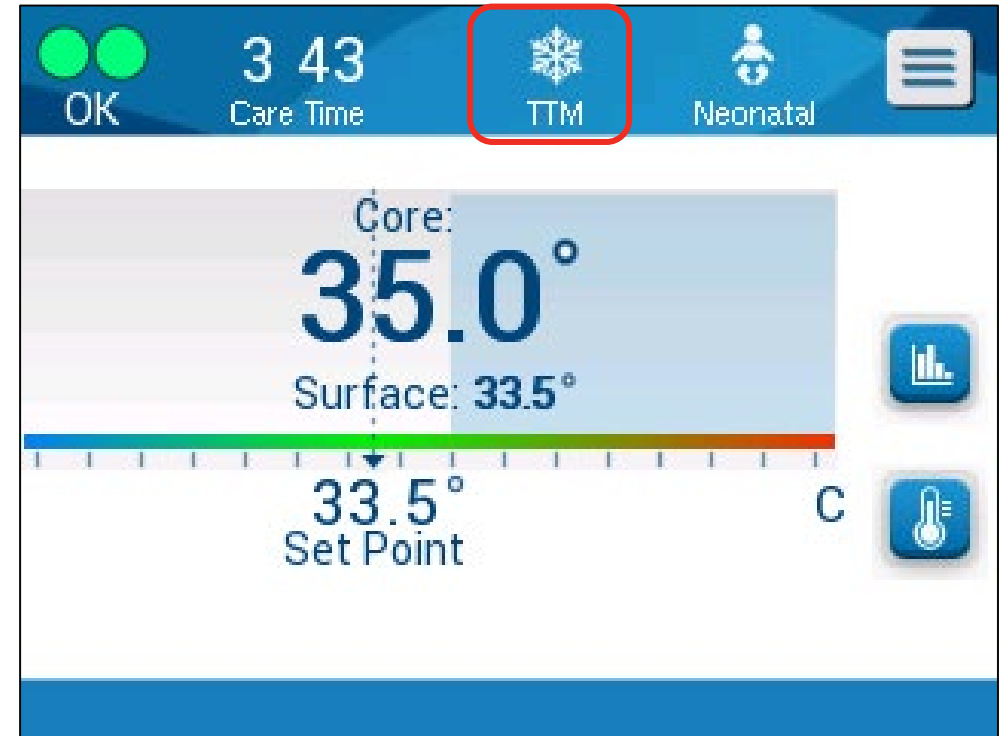

CONTROLLED REWARMING MODE – SLOW REWARMING

Controlled Rewarming Mode – An automatic patient rewarming mode intended for returning a hypothermic patient to normothermia

- Typically used after TTM Mode after the induction and then maintenance phases of Targeted Temperature Management.
- The hourly rewarming rate is preset in the Settings screen ("Rewarming Step") according to the hospital protocol.
- The patient will be warmed to the Target Temperature ("Target Temp."), the normothermic end temperature.

The CritiCool will reach the *Target Temp.* gradually by raising patient temperature according to the rewarming step per hour chosen in Settings.

- Target Temperature default: 36.5°C
- Target Temperature range: 32°C to 38°C
- Use the Target Temperature Touch/Soft Key (thermometer icon) to select a different target

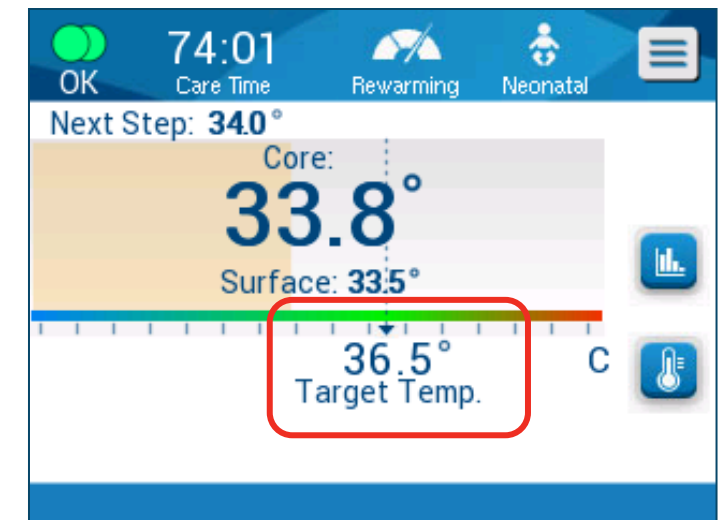
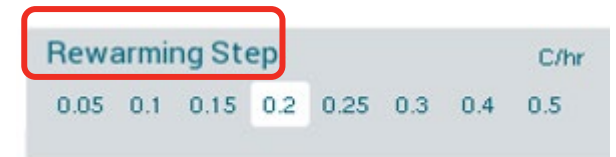

Controlled Rewarming Screen



CONTROLLED REWARMING MODE – REWARMING RATE

- Rewarming Step Default: **0.2°C/hour**
- Rewarming Step Range: **0.05-0.5°C/hour**
- The rewarming rate can be preset in the *SETTING* screen. This step represents the average hourly rate of rewarming over the rewarming period.
- The rewarming rate chosen in Settings will be reached on average over the course of the rewarming period.
- Patients may warm more in one hour and less in another, especially when beginning rewarming.
- Some patients naturally warm faster than others. The rewarming rate should be customized for the patient.
- Note:
 - **Rewarming Step** shown in Settings reflects the desired rate per hour.
 - **Next Step** shown on the rewarming screen reflects the next core temperature goal (Rewarming Virtual Set Point = RVSP)

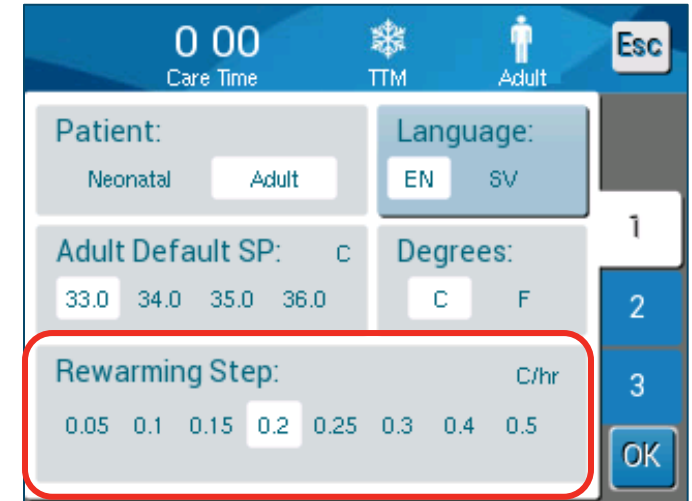

Settings Screen 1

CONTROLLED REWARMING MODE – INITIATING (1/3)

1. Press Menu
2. Press Mode Select
3. Select Controlled Rewarming and press OK to confirm

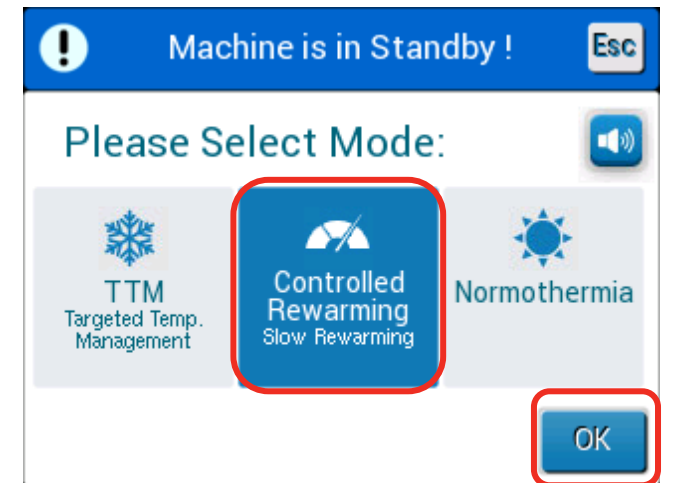
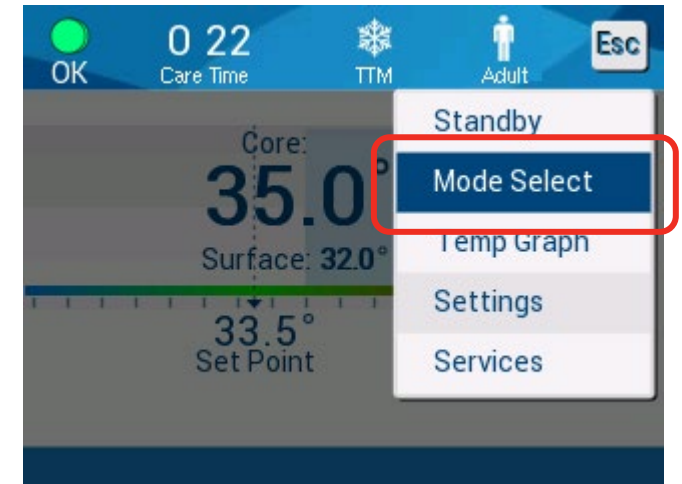

CONTROLLED REWARMING MODE – INITIATING (2/3)

- Two Messages Display:
 - "Temperature Regulation Paused"
 - "Switching to AutoRewarm Mode"

NOTE: While these messages appear, the Rewarming has not started yet!

- Follow onscreen instructions in this order:
 1. First confirm core temperature probe is secure and that core temperature reading is accurate and stable. It may take up to two minutes for the values to stabilize.
 2. Then Press OK (only AFTER checking probe).

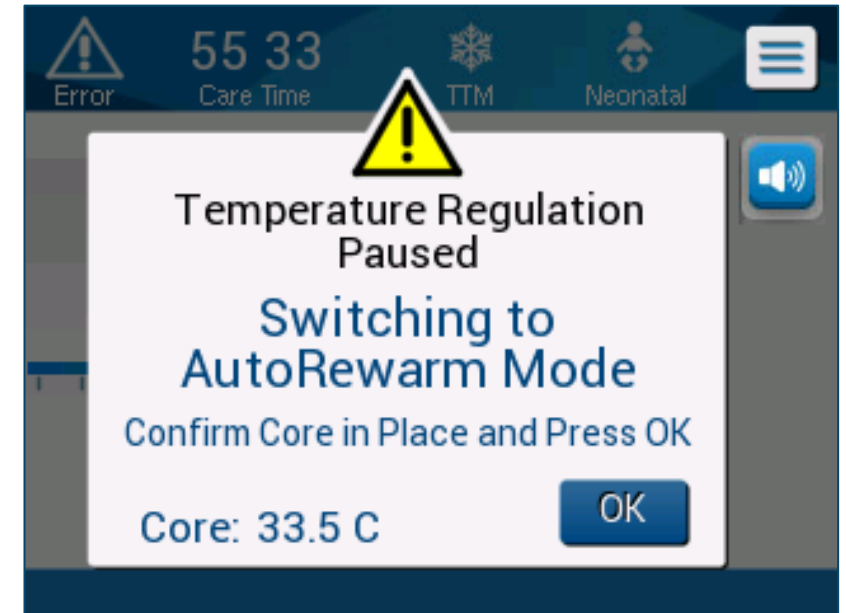

CONTROLLED REWARMING MODE – INITIATING (3/3)

When initiating Controlled Rewarming Mode:

1. Confirm the **Target Temperature** is appropriate and adjust as needed by using the Set Point Key, then pressing OK.

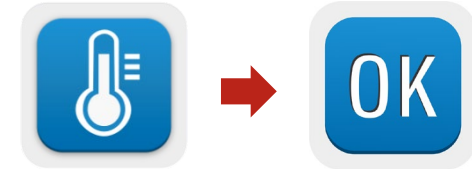

2. The first rewarming step will maintain patient temperature.

- A message will display for the duration of the rewarming step "Holding Core Temp for First Step of Rewarming".
- The duration will depend on the user-selected rewarming rate in Settings:
 - o 30 minutes: rewarming rates of 0.15°C/hour or faster
 - o 60 minutes: 1 hour: 0.10°C/hour rewarming rate
 - o 120 minutes: 0.05°C/hour rewarming rate

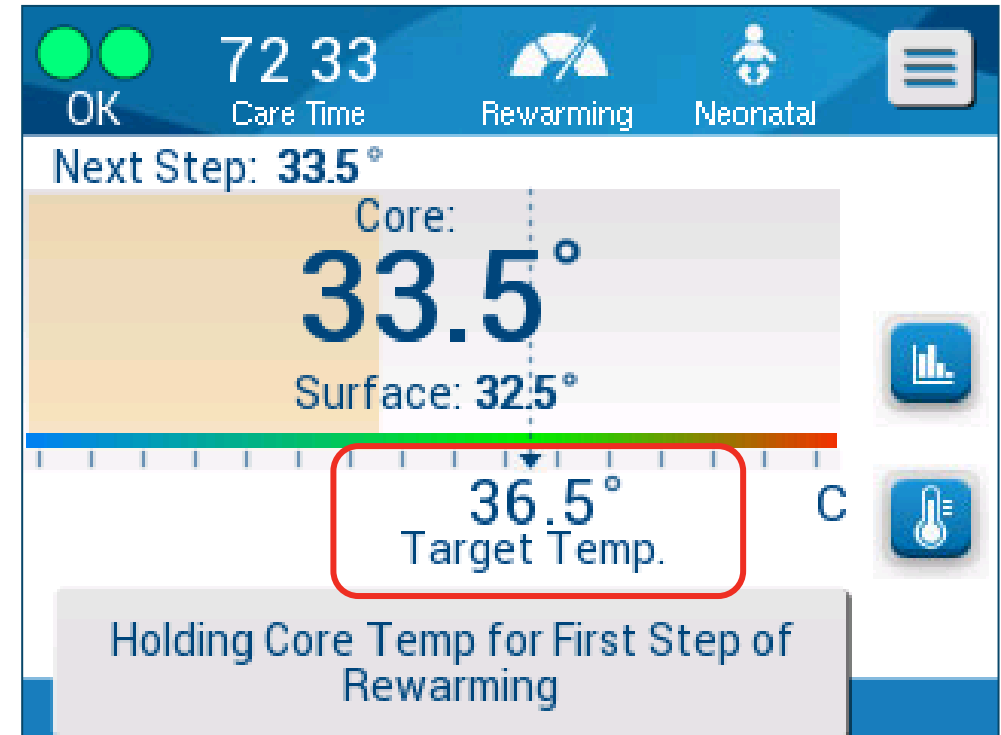

CONTROLLED REWARMING MODE – MONITORING PATIENT

When monitoring the patient while in Controlled Rewarming Mode:

1. Confirm the **Target Temperature** is appropriate and adjust as needed by using the Set Point Key, then pressing OK.
2. Confirm that the **Core Temperature** looks accurate, and then that the **Next Step** is equal or greater than the core temperature.

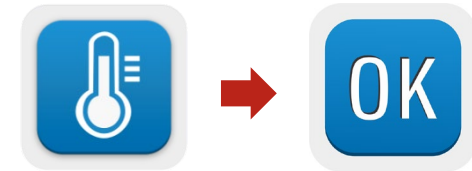

For most rewarming rates, Next Step will represent half of the rewarming rate per hour.

If the values do not appear as expected:

- Confirm the core probe is properly positioned.
- Wait until the core temperature reading is stable (up to 2 minutes).
- If the issue persists, then re-initiate Controlled Rewarming Mode:
 - o Menu → Mode Select → Controlled Rewarming → OK
- Repeat the process previously described.

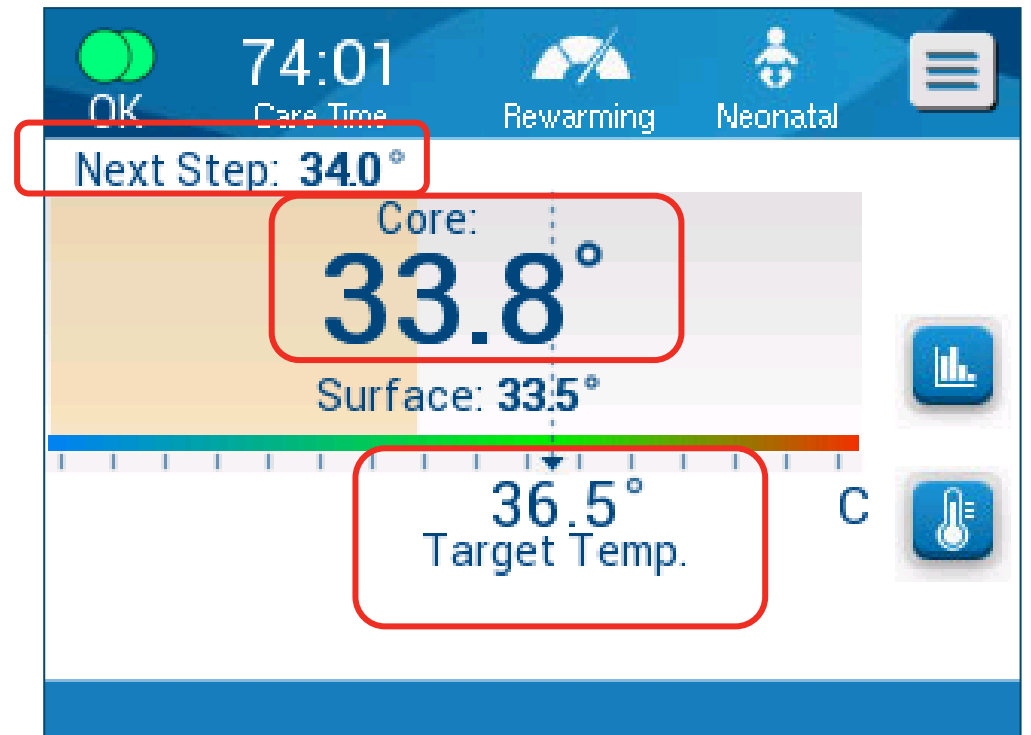

END OF CONTROLLED REWARMING

- Once the patient has reached the Target Temperature, a message will display "Target Temperature Has Been Reached."
 - Note: Message will only display if $RVSP \geq \text{Target Temperature}$ and $\text{Core} \geq \text{Target Temperature}$
 - Message will display for 60 minutes unless interrupted by another message exiting the mode.
- Then, either :
 - Switch to Normothermia mode to continue thermoregulation with CritiCool [MENU > Mode Select > Normothermia Mode], OR
 - Discontinue thermoregulation with CritiCool
- At the end of the procedure, to save procedural data:
 - Disconnect CliniLogger from CritiCool
 - Download and save data externally
 - Erase data on CliniLogger
 - Reconnect CliniLogger to CritiCool

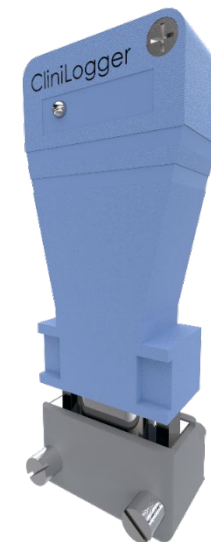
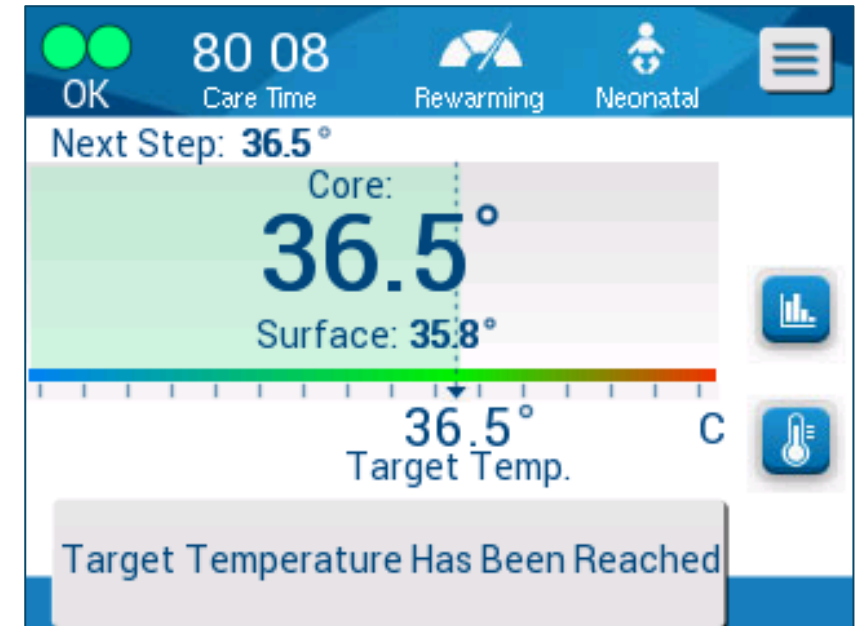

REWARMING BEST PRACTICES/TROUBLESHOOTING

- All thermoregulated patients should be closely monitored – especially when being rewarmed.
- Patient thermoregulation is patient-specific. Settings and protocols should be customized as appropriate at the discretion of the clinician.
- Factors that may impact thermoregulation may include, but are not limited to the following:
 - Patient condition/physiology (disease, age, shivering, etc.)
 - Pharmacology
 - Environmental factors (room temperature, etc.)
 - Positioning of the core temperature probe (depth and secureness)
 - Placement of the skin temperature probe (location and secureness)
- Other factors that can be adjusted via CritiCool by the clinician:
 - CureWrap Positioning (see CureWrap Instructions for Use)
 - Rewarming Mode
 - Controlled Rewarming Mode
 - Manual Rewarming in TTM Mode
 - Rewarming Rate
 - Controlled Rewarming Mode: Selected in Settings
 - TTM Mode: Controlled by changing Set Point every 30 minutes
 - Maintaining patient temperature during rewarming when appropriate
 - Controlled Rewarming Mode: Adjust Target Temperature
 - TTM Mode: Adjust Set Point
 - Re-initiating Controlled Rewarming Mode (recalculates the rewarming steps)
 - Menu > Mode Select > Controlled Rewarming > OK > "Switching to Rewarming" message.
 - Check core probe positioning, wait for on-screen core temp values to stabilize.
 - Press OK.





MAINTENANCE

CLEANING & DISINFECTING EXTERIOR SURFACES

Recommended disinfectants for external surfaces are:

- Chlorinated bleach solution (5.25% sodium hypochlorite concentration)
- Quaternary ammonium compounds (ammonium chloride as active ingredient)
- Germicidal Disposable Wipes (Sani-Cloth® or equivalent)

After each operation:

1. Make sure that the system is turned off.
2. Wait a few seconds, then close the clamps on the garment.
3. Remove the garment from patient and disconnect from machine. Dispose of the garment.
4. Disconnect the temperature sensors from patient and machine:
 - If they are Disposable Sensors: dispose of the sensors.
 - If they are Reusable Temperature Sensors: clean and disinfect according to the original manufacturer's IFU.
5. Disconnect the hoses and temperature sensor adapter cables (if used) from the machine.
6. Clean the exterior of the hoses and adapter cables (if used) with recommended disinfectants and store in a cool and dry place.
7. Clean the external surfaces of the machine:
 - Remove any soil or hard dirt with a dry cloth.
 - Gently clean the machine with recommended disinfectants.
 - Gently wipe the screen. Do not put physical pressure on the screen.
 - Gently wipe reservoir cap, chain, and ring
 - After cleaning, let the system dry for 10 minutes.



WATER CIRCUIT DISINFECTION INSTRUCTION (1 OF 4)

Disinfection Frequency

- Prior to First Use
- **At Least Once Every 3 Months**
- Before Long Term Storage (>3 Months)
- Before Use Following Long Term Storage of >3 Months

Required Tools for Disinfection

- Temperature Management Disinfection Kit (P/N 405-00015) includes:
 - Quantity 1 of 2-Connector Bypass Tube, P/N 200-00181
 - Quantity 1 of 3-Connector Bypass Tube, P/N 200-00098
 - Quantity 1 of Temperature Simulator, P/N 017-00245
- PPE (Personal Protective Equipment) per the NaDCC tablet manufacturer's instructions. See **Table 1** next slide.
- Sodium Dichloroisocyanurate (NaDCC) tablets in the recommended concentration
- Hospital-grade disinfecting wipes
- Sterile water / 0.22µm filtered water (approximately 12 Liters total)

Table 1

Tablets needed to achieve at least a 5382 ppm concentration of NaDCC











PurTabs® (13.1g)	Klorsept® 87 (17.4g)	Aquatabs® (8.68g)
8 Tablets per 6 L of water	7 Tablets per 6 L of water	7 Tablets per 6 L of water

NOTE: Do not use de-ionized water or water created through reverse osmosis as it may promote corrosion of the metal components of the system





WATER CIRCUIT DISINFECTION INSTRUCTION (2 OF 4)

Device Preparation & Disinfection

3. DEVICE PREPARATION AND DISINFECTION					
A.		<p>Ensure the device is powered OFF. Check the water tank level. If the water level is below the lower red line, add room temperature sterile or 0.22µm filtered water until the water level is between the 2 red arrows to ensure the machine has 6 L.</p> <p>NOTE: Alternatively, you can prepare this disinfection solution in a separate container per the NaDCC tablet manufacturer's instructions.</p>			
B.	PPE Required	Use the appropriate PPE per the NaDCC tablet manufacturer's instructions for use.			
	Add NaDCC	<p>Remove the cap, chain, and anchor ring from the device's water tank.</p> <p>Procure the appropriate NaDCC tablets and add the correct number to the device's water tank per <i>Table 1</i></p> <p>NOTE: Do not disinfect water circuit near the area of care.</p>			
C.	  	<p>Allow the tablets to dissolve for 15 minutes.</p> <p>While tablets are dissolving, perform the remaining steps in Step C.</p> <p>NOTE: Do not leave the dissolved tablet solution stagnant in the device's water tank for more than 20 minutes.</p>			
		<p>Wipe clean the cap, chain, and anchor ring with hospital-grade disinfecting wipes, then reattach the cap, chain, and anchor ring.</p>			
	<table border="1"> <thead> <tr> <th>2-Connector</th> <th>3-Connector</th> </tr> </thead> <tbody> <tr> <td> <p>P/N 200-00181</p>  </td> <td> <p>P/N 200-00098</p>  </td> </tr> </tbody> </table>	2-Connector	3-Connector	<p>P/N 200-00181</p> 	<p>P/N 200-00098</p> 
2-Connector	3-Connector				
<p>P/N 200-00181</p> 	<p>P/N 200-00098</p> 				

WATER CIRCUIT DISINFECTION INSTRUCTION (3 OF 4)

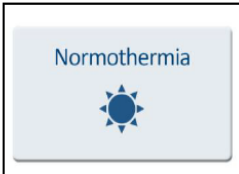

Device Preparation & Disinfection - Continued

D.	Plug in the device, power it ON, and allow the Self-Test to complete.	
E.		Select and operate the device in Normothermia mode. Set the patient setpoint to 37°C.
F.		Plug the temperature simulator (P/N 017-00245) into the core temperature socket on the front of the device and set it to 36.0°C ±0.3 by turning the dial and watching the display.
G.		Allow the solution to circulate for 5 minutes (minimum) to 6 minutes (maximum) to disinfect the device's water circuit. Place the device into Stand-by mode once completed.
H.	If you have a second set of blue hoses, disconnect the current set and attach the second set using the appropriate bypass tube assembly. Repeat Steps E – G.	
I.	Remove the bypass tube assembly from the connected blue hose set. Drain the solution from the device's water tank following the instructions in <i>Table 2</i> . Dispose of the cleaning solution per hospital protocol.	
J.	Flush Cycle	Proceed to Section 4 "Flush Cycle" to complete the disinfection and cleaning procedure.

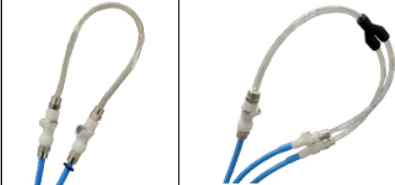

WATER CIRCUIT DISINFECTION INSTRUCTION (4 OF 4)

Flush Cycle

4. FLUSH CYCLE		
NOTE: Device MUST be flushed. If the device is not flushed, damage to the device's internal components may occur.		
A.		Refill the device with 6 L of sterile or 0.22µm filtered water (no NaDCC).
B.		Reconnect the appropriate bypass tube assembly to the blue hoses still connected to the device.
C.	 	Place the device back into Normothermia mode with the temperature simulator still set to 36.0°C ±0.3. Allow the water to circulate for at least 5 minutes before placing the device in Stand-by mode.
D.	If you have a second set of blue hoses, disconnect the current set and attach the second set and appropriate bypass tube assembly. Repeat Step C.	
E.	Remove the bypass tube assembly from the connected blue hose set. Drain the solution from the device's water tank following the instructions per <i>Table 2</i> . Refill the device with 6 L of room temperature sterile or 0.22µm filtered water if returning to use or leave tank empty if moving to storage.	
F.	Power OFF the device, unplug it and disconnect the blue hoses. Disconnect and store the temperature simulator (P/N 017-00245).	
DEVICE IS NOW READY FOR STORAGE OR NEXT PATIENT		
NOTE: This document does not replace the requirement to read the entire device user manual. For complete operations, maintenance and cleaning instructions, please refer to the device user manual.		



ROUTINE & PREVENTIVE MAINTENANCE

Frequency	Inspection/Service	Performed By
Before each use	<ul style="list-style-type: none"> • Clean connecting tubes and Quick Coupling Connector with a wet cloth. • Perform a visual inspection for any mechanical failure in probes, connecting tubes, and power cable. • Perform a visual inspection of the exterior of the CritiCool® System. 	Clinician or Hospital Staff
As required by hospital/clinic protocol	<ul style="list-style-type: none"> • Replace Connecting Water Hoses (PN #200-00109 and 200-00147) periodically. 	Clinician or Hospital Staff
Per Instructions found in “Water Circuit Disinfection Instructions” [slide 54]	<ul style="list-style-type: none"> • Disinfect Water Circuit 	Clinician or Hospital Staff
Annually	<ul style="list-style-type: none"> • Periodic Maintenance • Replace filter * • Thermal Disinfection application (optional) 	Belmont Medical Technologies authorized technician

* Filter replacement could be performed if needed more frequently than once a year (according to water quality) if needed.



SERVICE SCREEN

- **Empty:**
 - Use this mode to drain the water
- **System Check:**
 - An automatic system check (takes about 10 minutes)
- **Technician:**
 - A password protected screen for certified technicians
- **Thermal Disinfection:**
 - A password protected screen for certified technicians

Reference the Service Manual for further instructions.

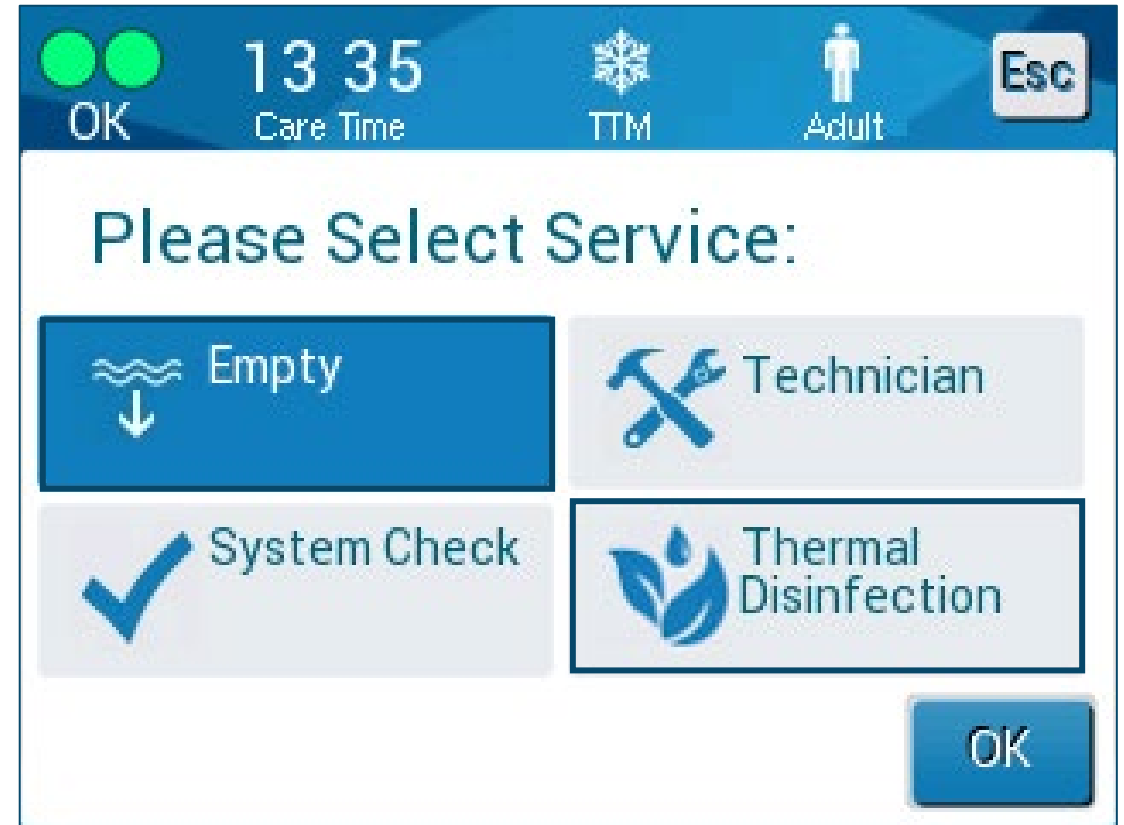

EMPTYING CRITICOOL

- Select *Service* from the *MENU*
- Select *Empty* and touch *OK* to confirm
- Connect water hoses and make sure the draining plug is connected
- Place water out hose with inserted drain plug into a sink or water receptacle
- Touch *Start* and wait for the message: *"water tank is empty"*
- Clean and disinfect the machine and accessories as per the hospital protocol

Drain Plug

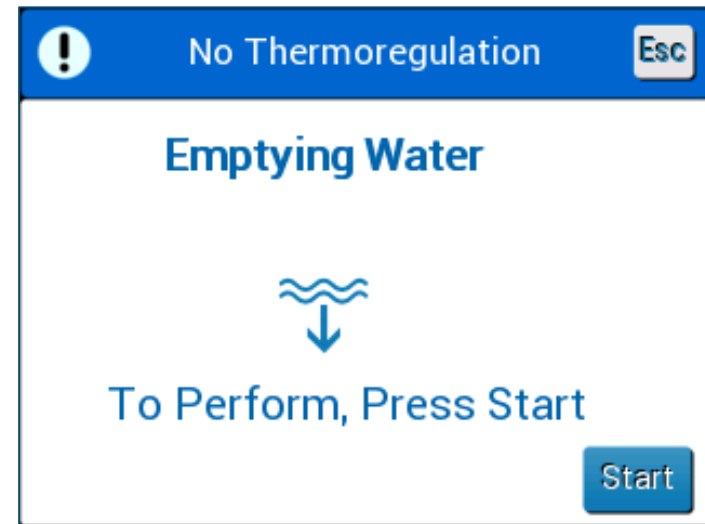
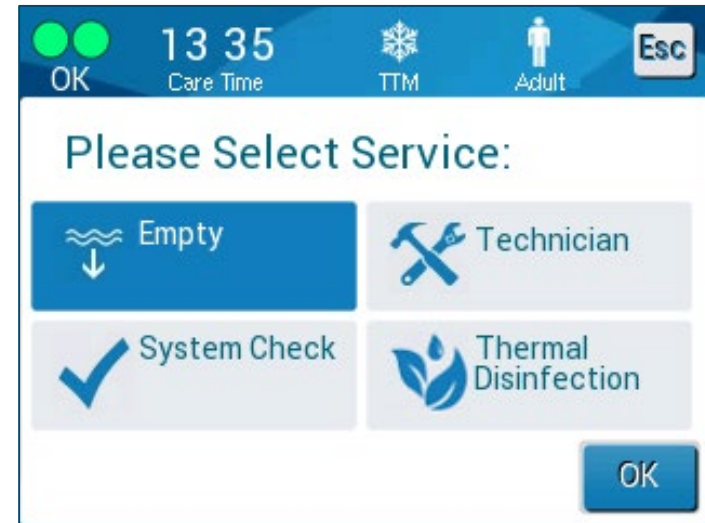

CritiCool must be emptied before storage.
See user manual for complete instructions.

THERMAL DISINFECTION MODE (OPTIONAL)

- Thermal Disinfection; also known as "Self-Cleaning"
 - Password Protected: Can only be accessed by a Belmont-trained Biomedical Technician
 - Should be performed annually as part of preventive maintenance

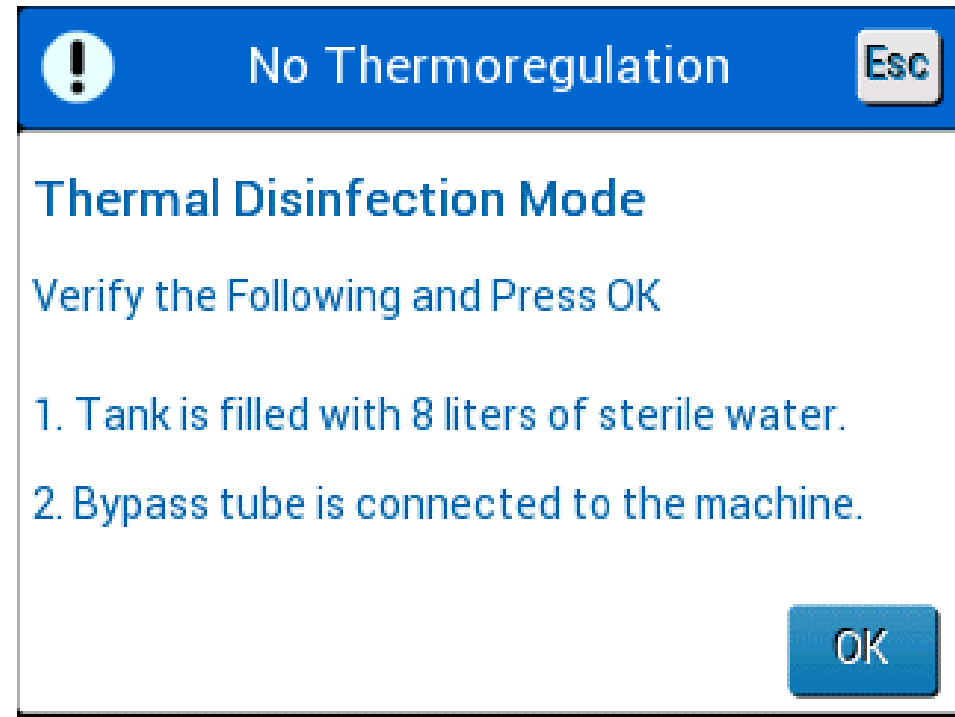
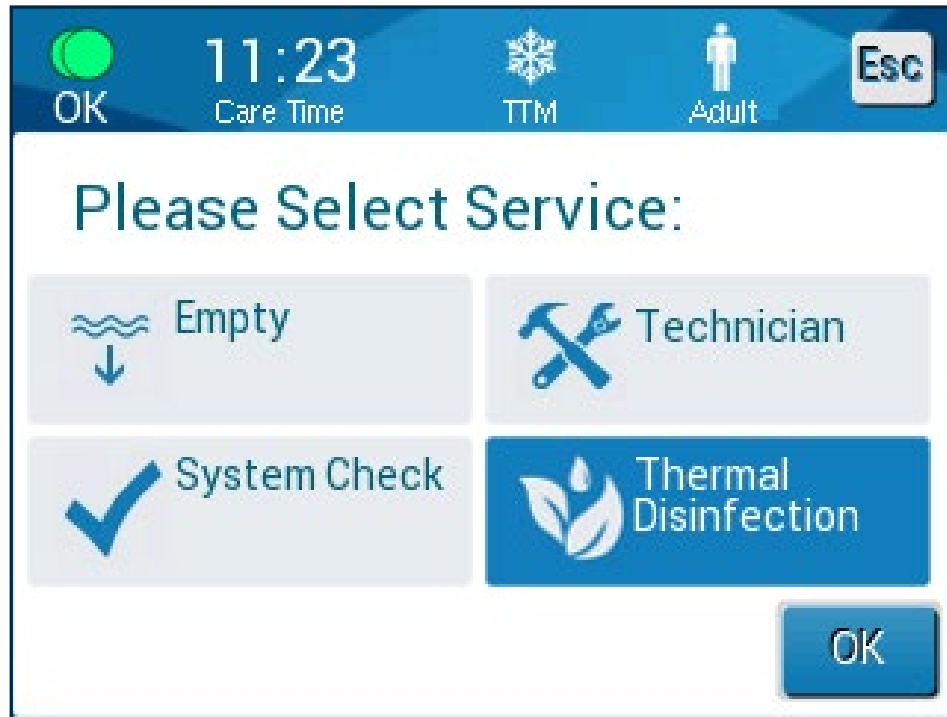



MESSAGES AND TROUBLESHOOTING

MESSAGES & TROUBLESHOOTING

CritiCool uses two types of messages:

Error Message

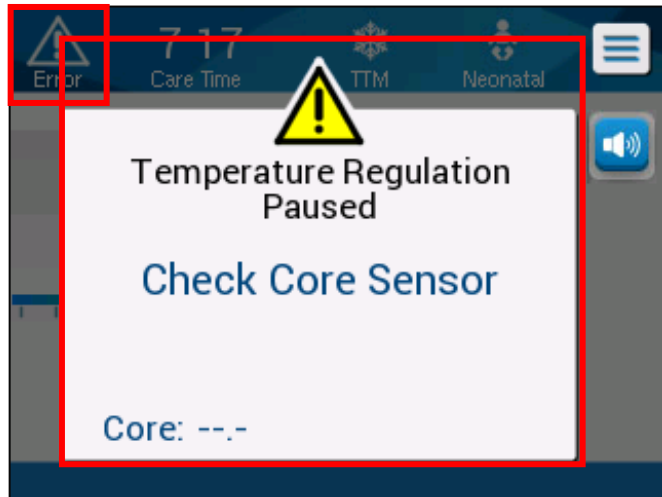

Informative Message



ALARM MESSAGE #3: SWITCHING TO REWARMING

When Switching to Controlled Rewarming Mode, Patient's Core temperature probe position should be confirmed to initiate the automatic process

- First check Core temp sensor position and fix if necessary. Wait for reading to stabilize.
- Touch  to confirm Core temp. and Start Rewarming
- **NOTE:** Be sure to probe is secure, ensure the readings are stable, then press OK. Do not press OK and then reposition probe.

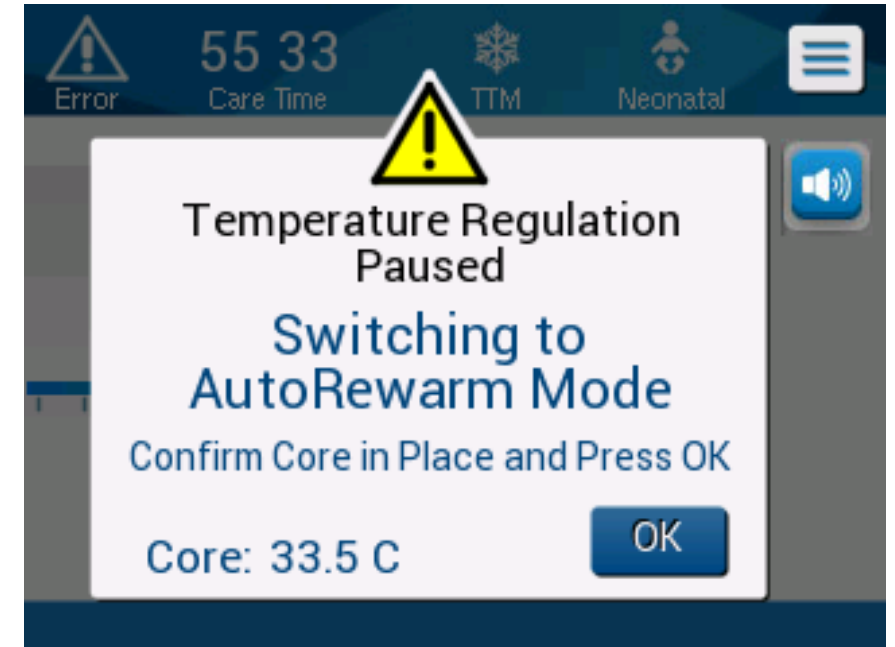

ALARM MESSAGE #1 (LOW CORE TEMPERATURE)

Core temperature is 0.8°C to 2°C lower than Set Point

- Staff awareness to patient's core temperature is needed
- No other action is needed



ALARM MESSAGE #2 (CORE READOUT TOO LOW)

Core Temperature is at least 2°C lower than Set Point or below 30.8°C, whichever happens first

- **Thermoregulation Paused!**
 - While displayed, CritiCool does not adjust water temperature based on core temperature. Water temperature may change.
- First check Core temp sensor position and fix if necessary
- Touch **OK** to confirm Core temp and resume thermoregulation
- **NOTE:** Be sure to fix probe position, ensure the readings are stable, THEN press OK. Do not press OK and then reposition probe.
- If in Controlled Rewarming, confirm Core, Target Temperature and Next Step look correct.
 - If not, re-initiate Controlled Rewarming Mode [Menu > Mode Select > Controlled Rewarming > OK > "Switching to Rewarming" message.]
 - Check core probe positioning, wait for on-screen core temp values to stabilize.
 - Press OK.



After the user acknowledges the message on the screen, water will once again flow to the wrap and CritiCool will not alarm for that condition for 30 minutes. If after 30 minutes the alarm conditions apply, it will once again stop water flow and alert the user.

ALARM MESSAGE #4: CHECK WATER TUBES

Water flow to CureWrap is interrupted

- Check the blue hoses are not kinked/bent
- Check that the blue hoses are flat near the CureWrap connections
- Check if the CureWrap is folded

The message will continue until the problem has been resolved.

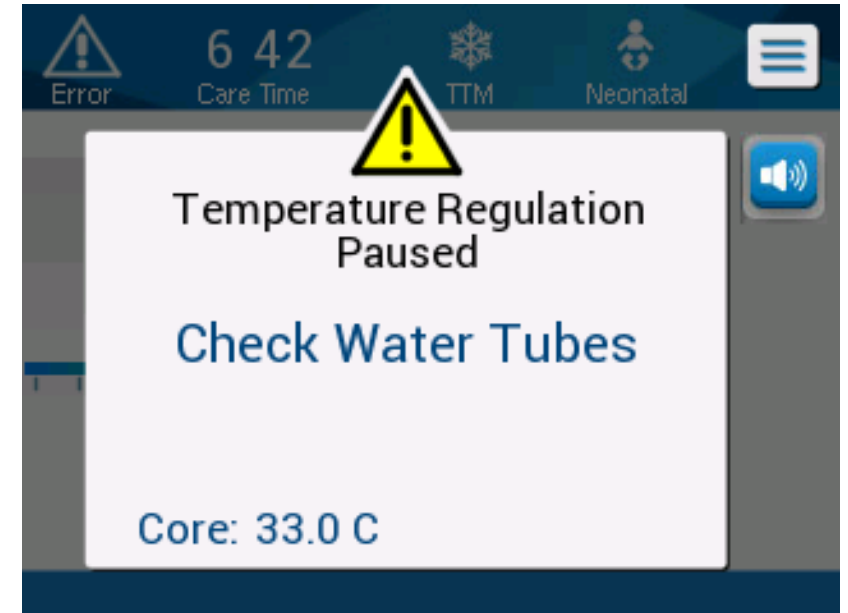

PRESSURE RELIEF ALGORITHM

- **Initial Phase of Regulation:**
(When patient has yet to reach the target temperature)
 - 12 minutes of water flowing
 - 1 minute of no water flow
- **Steady State**
(Once 90 minutes has passed and patient has reached the set point temperature):
 - 12 minutes of water flowing
 - 12 minutes of no water flow
- **At Any Point:**
 - Difference of $>0.3^{\circ}\text{C}$ between Set Point and Core Temperature will cause water to flow back into the wrap

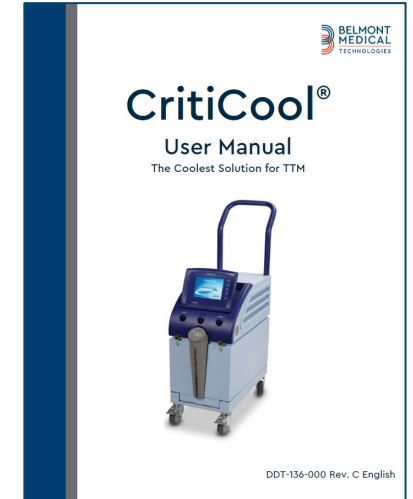

CritiCool® Device

The CritiCool® device has a microprocessor that controls the water temperature flowing into the wrap worn by the patient.

The decision as to the correct water temperature is based on the desired set point temperature and the actual measured patient temperature (core and surface).

Water flow in the wrap is regulated by timed pauses of the flow during clinical operation.

In TTM and Normothermia modes - during the initial phase of regulation the flow cycle is 12 minutes ON and 1 minute OFF.

In steady state (when the Core Temp is within the Set Point range) the cycle is 12 minutes ON and 12 minutes OFF.

The CritiCool® device is equipped with a handle for easy transport.

DIFFERENCES BETWEEN PATIENT MODES

	Adult Mode	Neonatal Mode
Default Set Point	33.0°C	33.5°C
Adjustable Default	Yes (in Settings Screen 1)	No
Adjustable Default Options	33.0°C, 34.0°C, 35.0°C, 36.0°C	N/A
>2.0°C between Set Point and Core Temperature stops water flow to the wrap	Only in TTM Mode if patient core temp <30.8°C	Yes, always*
Patient temp drops below 30.8°C	No water flow to the wrap	No water flow to the wrap

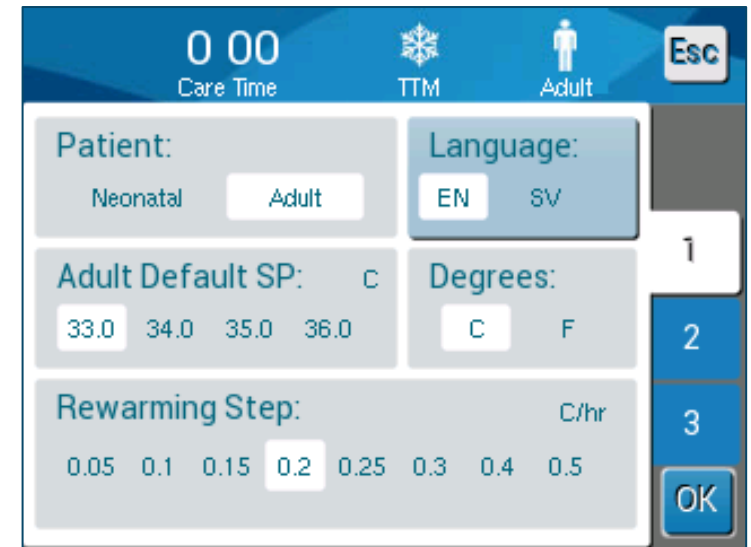

*After the user acknowledges the message on the screen, water will once again flow to the wrap and CritiCool will not alarm for that condition for 30 minutes. If after 30 minutes the alarm conditions apply, it will once again stop water flow and alert the user.

NEONATAL PATIENT MODE

- **Default Set Point: 33.5°C**
(Set point temperature range: 30-40°C)
- To change the set point:
 - Press the thermometer key
 - Choose the desired temperature

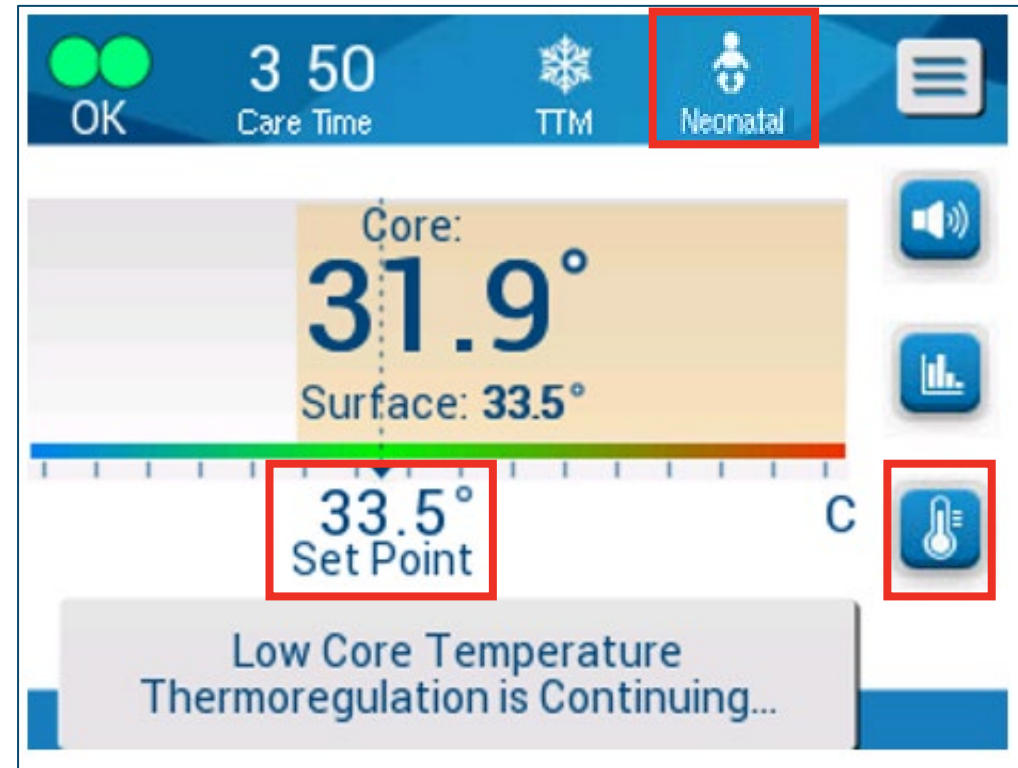

ADULT PATIENT MODE

- Default Set Point: 33.0°C
- To change the set point:
 - Press the thermometer key
 - Choose the desired temperature
 - Select OK(Selection will not be default)

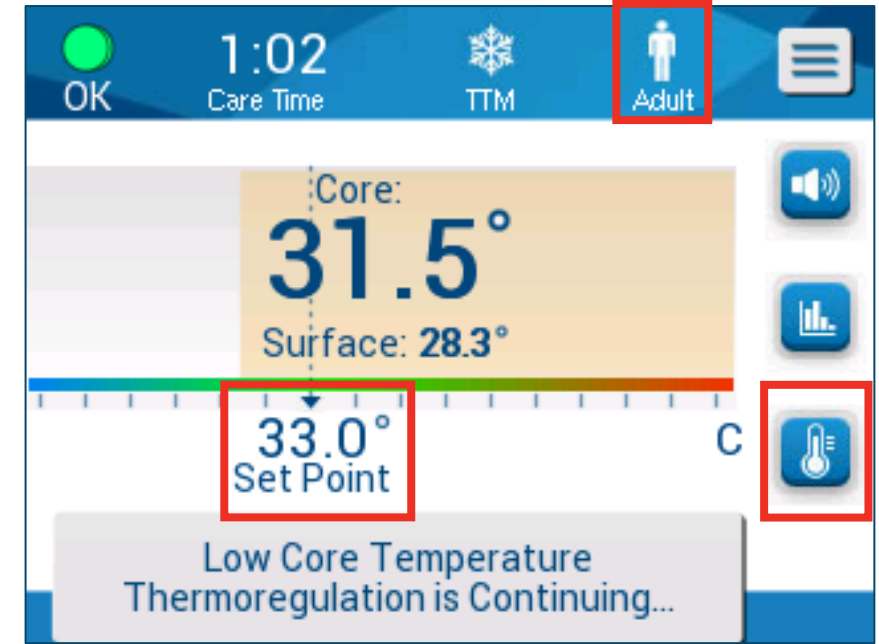
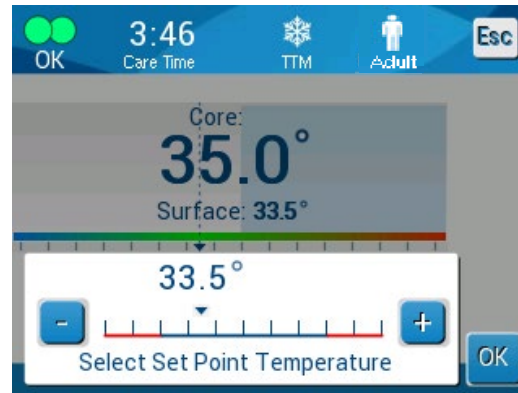

- To change the default set point:
 - Press the MENU button
 - Press **Settings**
 - Adjust **Adult SP** by choosing among: 33.0, 34.0, 35.0 or 36.0 (see #3 at right)
 - Select OK(Selection will be default in future)

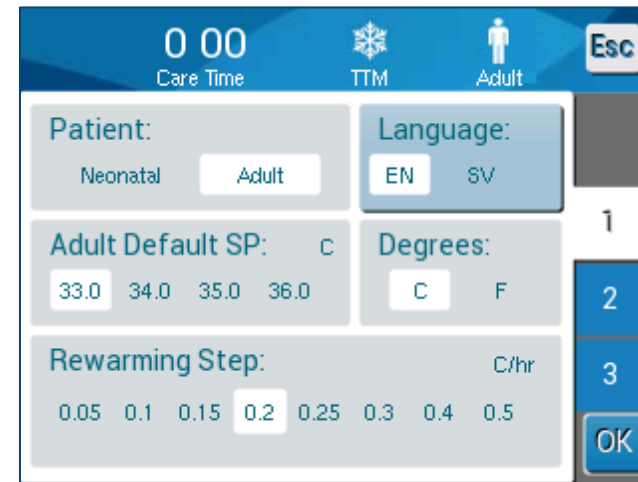

WATER TEMPERATURE SETTINGS

- Water temperature (WOut) is visible on the temperature graph screen.
- Water Temperature Range:
 - 13°C – 40.8°C
- Alarms when water temperature is >42°C or <10°C
 - Default high water temp alarm is 42°C
 - Keep it there
- Automatically stops flowing into wrap if water temperature >42°C
- If water temperature >43°C (no water flow), the pump stops, the thermoelectric coolers (TECs) are automatically turned off and the unit shuts off with Halt 3.
- **Note:** *High Water Temperature* does not control the water temperature; it alarms when the value is reached.

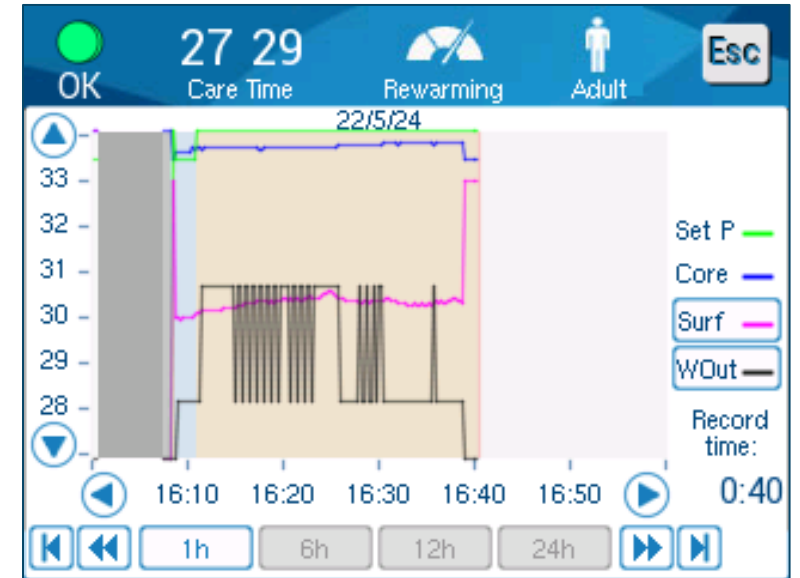

The figure shows the 'Adjustable Alarm Limits' screen. At the top, there is a status bar with a green circle, 'OK', '4 16', 'Care Time', 'TTM', 'Adult', and 'Esc'. The screen displays three adjustable alarm limits:

Alarm Type	Limit 1 (°C)	Limit 2 (°C)	Limit 3 (°C)
High Patient Temperature	36.0	36.5	37.0
Low Patient Temperature	31.0	32.0	33.0
High Water Temperature	36.0	37.0	38.0

Each limit is accompanied by a circular icon with a number (1, 2, or 3) and a 'C' for Celsius. The 'High Water Temperature' limit is currently set to 38.0°C. An 'OK' button is located at the bottom right of the screen.

TEMPERATURE SPLITTER

- Shares patient core temperature with an external device
- Optional accessory
- Often requires additional core adapter cable PN# 014-00028
- Review the [Instructional Video](#)

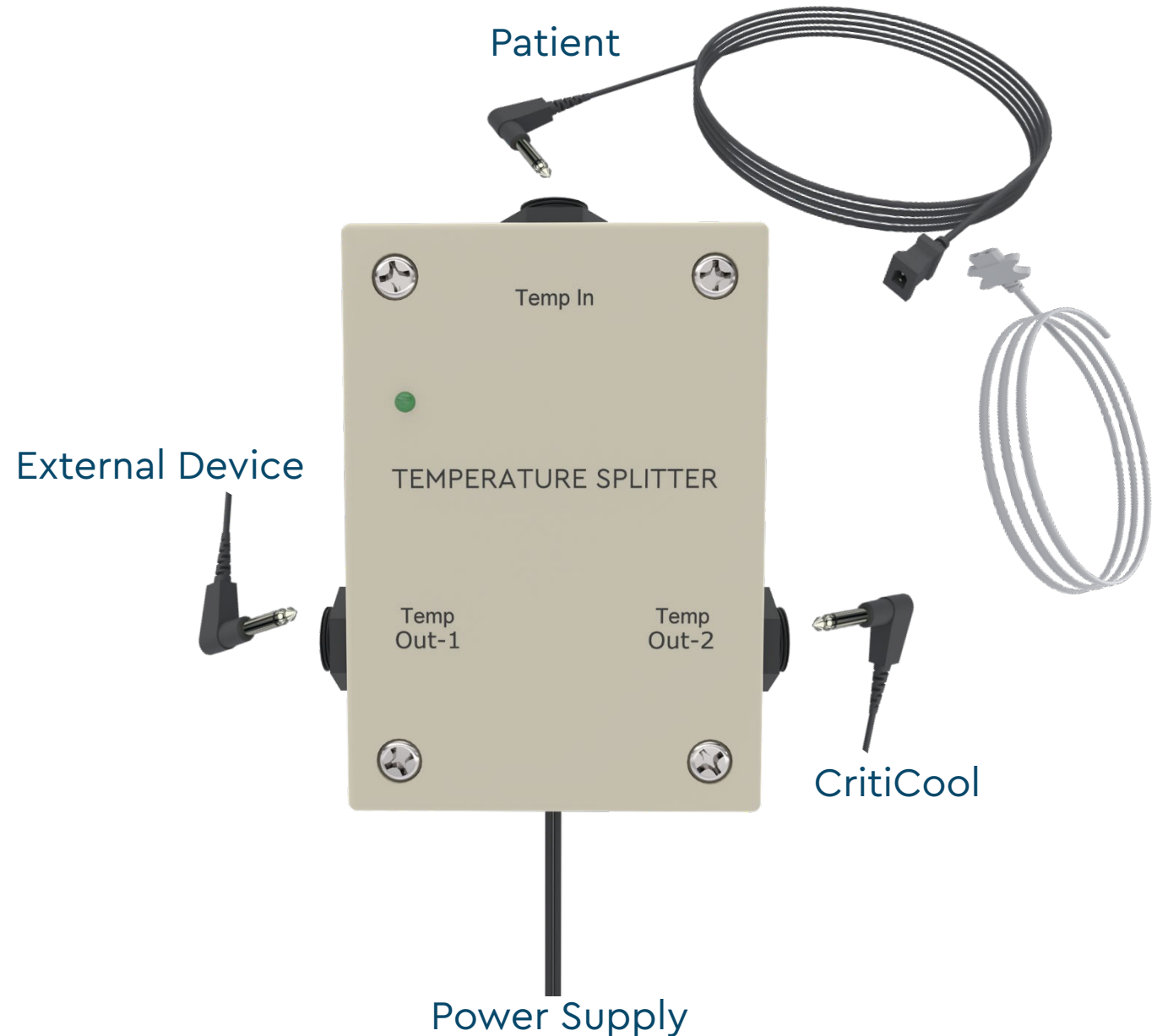

SOFTWARE VERSION 6.4: ADDITIONAL INFO PROVIDED

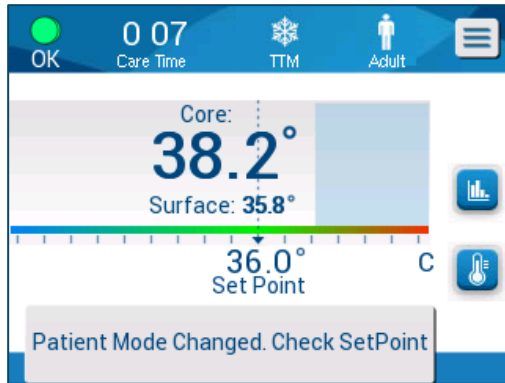

FROM: No message.

TO: New message:
"Patient Mode
Changed. Check
SetPoint."

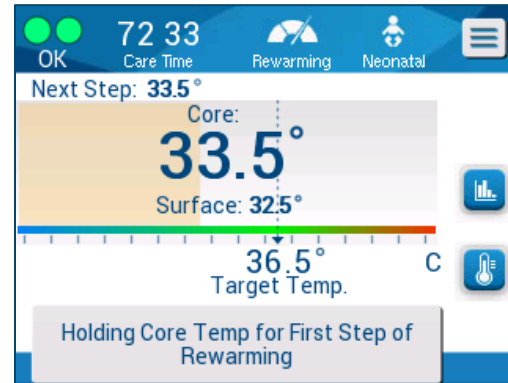

FROM: No message.

TO: New message:
"Holding Core Temp
for First Step of
Rewarming."



FROM: No message.

TO: New message:
"Target Temperature
Has Been Reached."

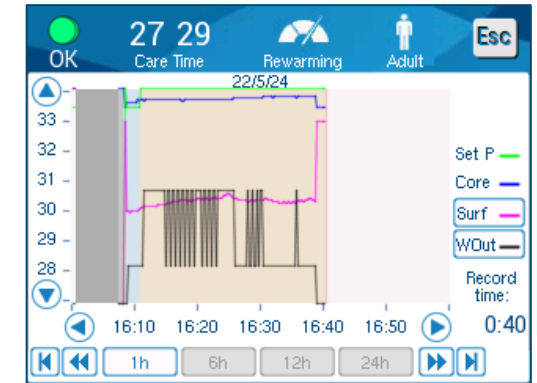

FROM: Water
temperature not shown.

TO: Water temperature
shown (WOut).

POWER INTERRUPTS

- CritiCool Version 6.4 / After July 2024:

CAUTION!

Power interruptions shorter than 10 minutes return the machine to the mode that was operating before the interruption with a 3-beep alarm. Power interruptions of 10 minutes or longer return the machine to the parameters selected in the Settings menu.

IMPORTANT!

*Make sure to read the messages to ensure correct reactivation of the machine.
If a power outage occurs when using Controlled Rewarming Mode, the user should reinitiate Controlled Rewarming Mode. See page 71 for instructions.*

- CritiCool Version 6.3 / July 2020 – June 2023:

CAUTION!

Power interruptions shorter than 10 minutes return the machine to the mode that was operating before the interruption with a 3 beep alarm.

CAUTION!

Power interrupts affect the functionality of the system, depending on the mode of operation

- *Interrupts longer than 10 seconds return the machine to the Start-up Screen. A beep is heard when the power is returned to indicate that the machine has returned to the StartUp screen.*
- *Interrupts shorter than 10 seconds return the machine to the mode that was operating before the interruption, but a warning will appear.*

IMPORTANT!

Make sure to read the messages in order to ensure correct reactivation of the machine.

- CritiCool Versions 6.2 and earlier:



PACKING CRITICOOL FOR SHIPMENT

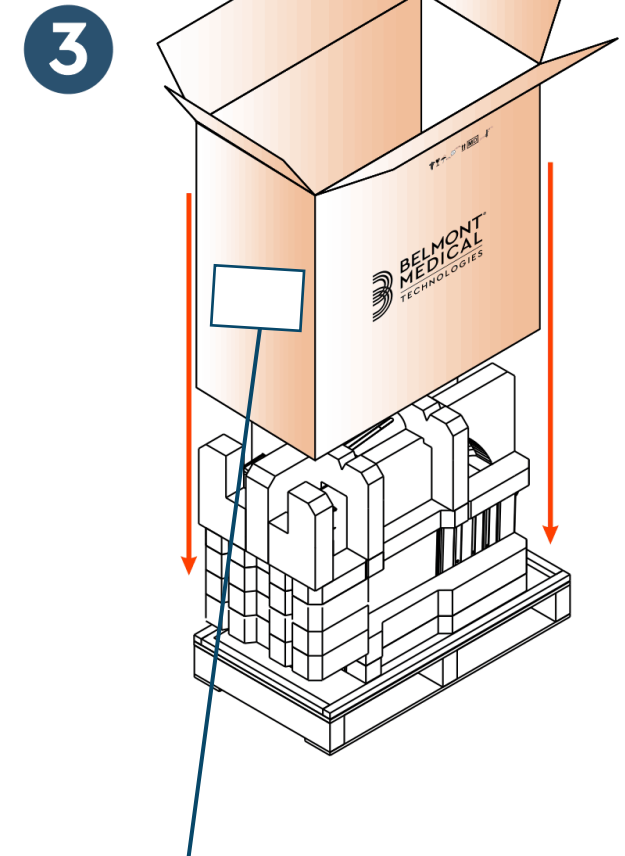
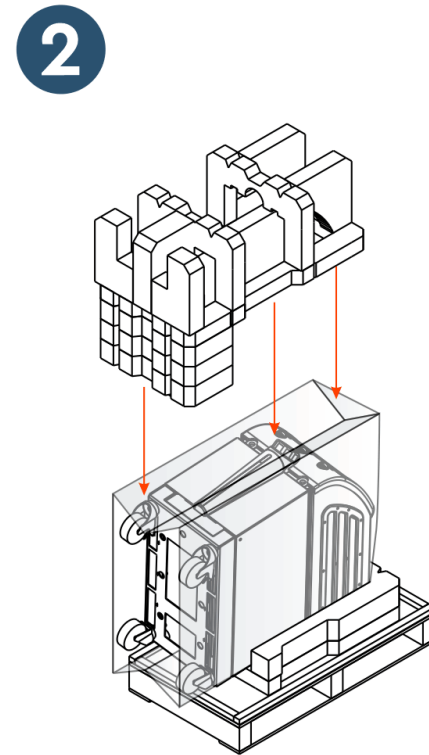
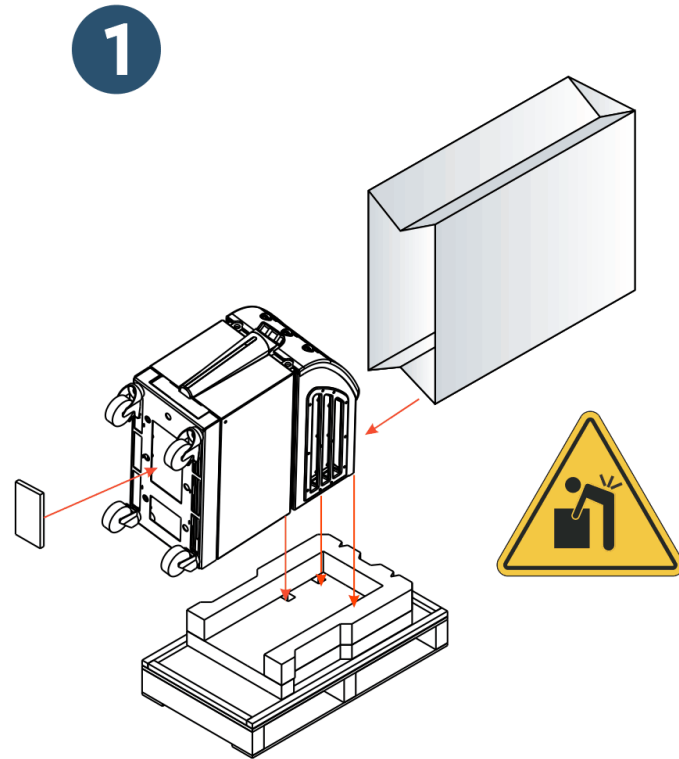

Note: CritiCool must always ship in the Belmont box!

Packing instructions are affixed to the box. Please refer to instructions on the box.

PACKING CRITICOOL FOR SHIPMENT

4

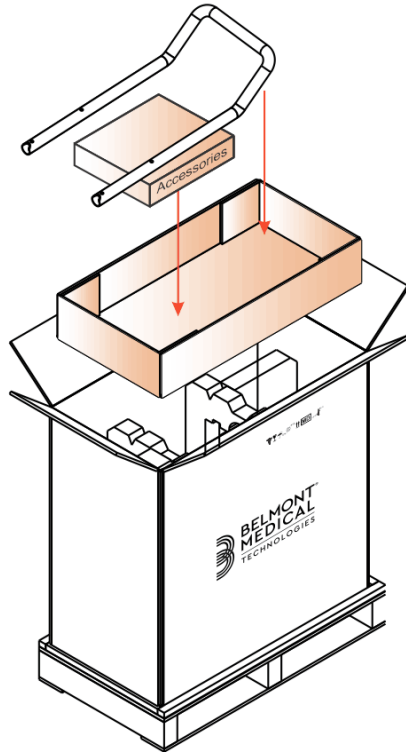

5



6

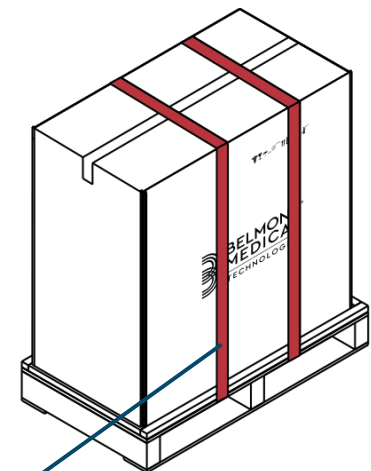

General purpose straps are needed for shipping and are not included with the shipment.

PASSCODE FOR SETTINGS SCREEN

- The passcode 6873 can be found:
 - Settings section in CritiCool User Manual
 - Appendix A at the end of the CritiCool User Manual

Chapter 4: Operating Instructions

Settings

The settings panels consist of four pages of default settings for the system.

NOTE: *The settings menu is password protected. Only authorized personnel may change the settings.*

The passcode for the Settings screen is 6873.

To pre-configure the settings:

1. From the Menu panel, choose **Settings**.
2. Enter the password. The Settings window appears.
3. Touch the page numbers to move between the pages.

APPENDIX A:

Belmont Medical Technologies CUSTOMER SERVICE REPRESENTATIVE

WARNING!!! The following details are necessary to contact your Belmont Medical Technologies representative. Keep this form with the User Manual for scheduling annual periodic maintenance and/or servicing needs.

Representative Name:	
Company Name:	
Address:	
Telephone No:	
Fax:	
E-mail:	

CritiCool® Passcode for the Settings Screen: **6873**



IMPORTANT POINTS

- The CritiCool cannot thermoregulate without a valid Core readout.
- If "Core Readout Too Low" appears on the screen, check the core probe positioning, reposition if necessary, and wait for the core temp reading to stabilize first. Then press OK.
- Use sterile water or 0.22 micron filtered water only.
- CritiCool cools the water upon startup. If normothermia is the goal, to avoid cooling the water, limit the time the device is turned on but not fully set up.
- CureWrap should be filled with water prior to wrapping and securing on patient.
- CureWrap should stay one finger loose on the patient.
- Do not use the CureWrap to lift the patient.
- Avoid handling the CureWrap with sharp objects.
- The rate of temperature changes depends on the size and weight of the patient.
- Patients being thermoregulated should be closely monitored at all times.





BELMONT[®]
MEDICAL

TECHNOLOGIES

TECHNICAL SUPPORT

USA: 855.397.4547

WORLDWIDE: +1.978.663.0212

TECHSUPPORT@BELMONTMEDTECH.COM

WWW.BELMONTMEDTECH.COM

THANK YOU

