



# THE BELMONT<sup>®</sup>

---

## RAPID INFUSER RI-2





# THE BELMONT<sup>®</sup> RAPID INFUSER RI-2

## OPERATOR'S MANUAL

For use by trained medical professionals by physician prescription only



**BELMONT<sup>®</sup>**  
**MEDICAL**  
TECHNOLOGIES

All service calls & questions  
should be directed to:

USA: +1.855.397.4547  
Worldwide: +1.978.663.0212



Belmont Medical Technologies  
780 Boston Road  
Billerica, MA 01821, USA

EC REP

CE 1434

Emergo Europe  
Westervoortsedijk 60  
6827 AT ARNHEM  
The Netherlands  
+31 (0) 70 345 8570

# The Belmont® Rapid Infuser RI-2 Operator's Manual

## Table of Contents

<b>Chapter 1: System Overview</b> .....	<b>7</b>
Introduction .....	7
User Environment.....	7
Indications For Use.....	7
Contraindications.....	8
Overview of The Belmont® Rapid Infuser RI-2 .....	8
Major Components of the Control System .....	9
Control Panel: Display and Keys .....	10
<b>Chapter 2: Operation</b> .....	<b>11</b>
Introduction .....	11
<i>Warnings</i> .....	11
<i>Cautions</i> .....	12
Compatible Fluids.....	13
Step-By-Step Operating Procedures .....	14
<i>Inspecting the System</i> .....	14
<i>IV Pole Mounting</i> .....	14
<i>Installing the Disposable Set</i> .....	15
<i>Installing the Optional Large Reservoir</i> .....	16
<i>Powering On the System</i> .....	17
<i>Installing Fluid Bag</i> .....	18
<i>Prime Screen</i> .....	18
<i>Priming the Main System</i> .....	18
<i>Priming the Patient Line</i> .....	19
<i>Connecting to the Patient</i> .....	19
<i>Initiating Infusion</i> .....	20
<i>Maintaining Infusion</i> .....	20
<i>Infuse Screen</i> .....	20
<i>Pressure Control</i> .....	21
<i>Automatic Air Purging</i> .....	21
<i>Automatic Air Purging Screen</i> .....	21

<i>Bolus Infusion (Infuse a Fixed Volume)</i> .....	21
<i>Recirculation</i> .....	22
<i>Battery Operation</i> .....	23
<i>Low Battery</i> .....	23
<i>Accidental Power Off</i> .....	23
<i>Accidental Power Off Screen</i> .....	23
<i>End of Procedure</i> .....	24
<i>System Error</i> .....	24
<b>Chapter 3: Alarms and Troubleshooting Guide</b> .....	<b>25</b>
Introduction .....	25
Information Signals .....	25
Operational Alarms .....	26
<i>Air Detection</i> .....	26
<i>Fluid Out</i> .....	26
<i>Door Open</i> .....	27
<i>High Pressure</i> .....	27
<i>Missing Disposable</i> .....	27
Heating Alarms .....	28
<i>System Error #101</i> .....	28
<i>System Error #102</i> .....	28
Hardware Alarms .....	29
<i>System Error #201</i> .....	29
<i>System Error #202</i> .....	29
<i>System Error #203</i> .....	29
<i>System Error #204</i> .....	29
<i>System Error #205</i> .....	29
<i>System Error #206</i> .....	29
<i>System Error #207</i> .....	30
<i>System Error #208</i> .....	30
<i>System Error #209</i> .....	30
<i>System Error #210</i> .....	30
Troubleshooting Other Operational Difficulties .....	31

<b>Chapter 4: Parameters Setting and Preventative Maintenance .....</b>	<b>33</b>
Introduction .....	33
System Setup .....	34
1. <i>Date/Time</i> .....	35
2. <i>Display Brightness</i> .....	36
3. <i>Language Setup</i> .....	36
4. <i>Key Rate</i> .....	36
5. <i>Bolus Volume</i> .....	36
6. <i>Pressure Limit</i> .....	36
Service and Preventive Maintenance Schedule .....	37
<i>Schedule 1</i> .....	37
<i>Schedule 2</i> .....	37
Routine Maintenance .....	38
1. <i>Clean Device Exterior</i> .....	38
2. <i>Disinfect Device Exterior</i> .....	40
3. <i>Power Cord</i> .....	41
Testing the System and Operational Check-Out .....	42
<i>Material Required:</i> .....	42
1. <i>Visual Inspection</i> .....	42
2. <i>Seals</i> .....	43
3. <i>Instrument Door and Ceramic Disks</i> .....	43
4. <i>Rubber Feet</i> .....	43
5. <i>System Operational Check-Out</i> .....	44
6. <i>Battery Run Time</i> .....	44
7. <i>Electrical Safety Test - Leakage Current</i> .....	45
8. <i>Hardware Verification</i> .....	46
9. <i>Clean the Pump Head</i> .....	51
Checklist .....	52
Fuse .....	54
Calling for Service .....	54
Electromagnetic Compatibility .....	54

<b>Chapter 5: Technical Specification of The Belmont® Rapid Infuser RI-2 .....</b>	<b>56</b>
Technical Specifications of the Belmont® Rapid Infuser RI-2 .....	56
Dimensions .....	56
Portability .....	56
Power AC .....	56
Battery .....	57
Environment .....	57
Operating Parameters .....	57
Operating Panel .....	58
Safety and Monitoring.....	58
Alarm States and Controls.....	59
Disposable Sets .....	59
Disposable Environment.....	59
Disposable Symbols and Definitions.....	59
Classifications .....	60
Symbols and Definitions .....	61
Waste Electrical and Electronic Equipment (WEEE).....	62

**It is essential that you read and understand this manual before operating the system.**

### Introduction

The **Belmont® Rapid Infuser RI-2**, warms blood, colloid, and crystalloid to physiologic temperature at user-set rates from 10 to 750 milliliters per minute (ml/min) with 1000 ml/min as an option. 2.5 and 5.0 ml/min (150 and 300 ml/hr) are also available to keep the venous line open.

The system monitors temperature, line pressure, and air in the fluid path to ensure safe operation and alarms at all unsafe conditions. A hardware override circuit prevents unsafe operation in case of system computer failure. A screen displays flow rate, total fluid infused, temperature, line pressure, alarm and status messages and proper procedures to proceed safely after an alarm situation. Keys appropriate to a particular point in the operation are displayed on the touch screen.

A battery backup allows for mobile transport of the patient. During battery operation, fluid warming is disabled while pump operation and safety monitoring remain active. The built-in rechargeable battery automatically charges whenever the system is connected to line power.

NOTE: Federal law (USA) restricts this device to sale by or on the order of a physician.

### User Environment

The operating environment for the Belmont® Rapid Infuser RI-2 is general operation in hospital or alternate care environments. The Belmont® Rapid Infuser RI-2 will be subject to the temperature, humidity, and pressure typical of a health care environment. Sources of shock, drop and vibration are also those typically found in a health care environment. The Belmont® Rapid Infuser RI-2 is intended to be used by trained healthcare professionals.

### Indications For Use

The Belmont® Rapid Infuser RI-2 is designed to be used in general operation in hospital or alternate care environments to provide warmed blood and fluids to any patients requiring warmed infusion from 2.5mL/min to 1000mL/min.

- Intravenous infusion of crystalloid, colloid, or blood product, including packed red blood cells, as volume replacement for patients suffering from blood loss due to trauma or surgery.
- Intravenous infusion of warmed fluid to re-warm patients after surgery or for hypothermia.
- Infusion of warmed fluid for irrigation in urology procedures.

### Contraindications

The Belmont® Rapid Infuser RI-2 is designed to provide warmed blood and fluids from 2.5mL/min to 1000mL/min and should not be used where rapid infusion is medically contraindicated.

- The system should not be used to warm platelets, cryo-precipitates, granulocyte suspensions or unprocessed / non-anti-coagulated blood products.
- This system is not intended for drug administration.
- Calcium containing solutions (ex. Lactated Ringer's solution), dextrose in water, and hypotonic sodium chloride solutions should not be added to blood components. Use only anticoagulated blood products.

### Overview of The Belmont® Rapid Infuser RI-2

The complete system consists of the Belmont® Rapid Infuser RI-2 **Control System**, which can be mounted on an IV pole, and the **Disposable Set**. **The Belmont® Rapid Infuser RI-2 can be used only with the supplied disposables.** A large volume 3-liter reservoir is available as an optional accessory for convenience in cases involving very large infusion volumes, see page 16.

The **Disposable Set** is preassembled and has a sterile fluid path. **It is intended for single patient use only.**

**Disclaimer:** the IV pole is not required for use; it is not considered a critical-detachable component and ordering an IV pole from Belmont is optional.



## Major Components of the Control System

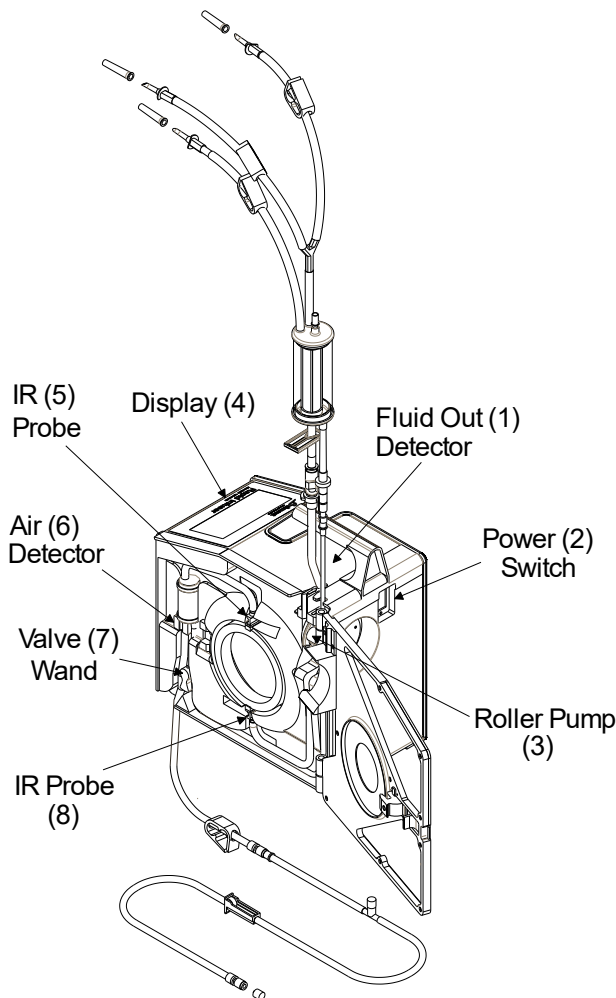

System Diagram Showing Main Components

1. Fluid Out Detector detects and alarms at an out of fluid situation.
2. Power Switch turns system power on and off.
3. Roller Pump is designed for pumping accuracy and reliability.
4. Display and control panel show status and alarm messages with touch keys at the bottom of the screen.
5. IR Temperature Probe (Output Probe) monitors output fluid temperature as it exits the Heat Exchanger.
6. Air Detector detects air in the line. If air is detected the valve wand is closed immediately to prevent air into the patient. Pumping and heating stop, alarm sounds and "Air Detection" message is displayed on screen.
7. Valve wand closes off the recirculation line when the system is in the infusion mode and closes off the infusion line when the system is in the recirculation mode. It immediately closes the infusion line to the patient when an error condition occurs which may require user intervention.
8. IR Temperature Probe (Input Probe) monitors input fluid temperature as it enters the Heat Exchanger.

### Control Panel: Display and Keys

The control panel consists of the touch screen display, which incorporates a bright graphical display with touch pad keys. The display shows status and alarm messages at the top and middle and contains the touch keys at the bottom.

#### CONTROL PANEL SUMMARY

##### Status Display:

- **Flow Rate in ml/min (The Belmont® Rapid Infuser RI-2 displays both the user Set Flow Rate and the Actual Flow Rate)**
- **Volume Infused**
- **Infusate Temperature in °C**
- **Pressure in the Fluid Line in mmHg**
- **Bolus Volume (when infusion of a fixed bolus of fluid is desired).**

**Function Keys:** The keys that control all system functions are displayed on the screen. The screen is changed each time a function key is pressed. Only keys that are relevant to the desired function are presented. The active key is highlighted.

There are three (3) different levels of sensitivity: Fast, Medium, and Slow. The key sensitivity is set at the factory to Fast but can be adjusted by the operator in SERVICE MODE.

**See Chapter 4, page 36 for 'Key Rate' sensitivity setup.**

**Alarm Display:** Graphical alarm messages indicating where errors have occurred and suggested operator action.

## Chapter 2: Operation

### Introduction

This chapter explains the procedure for setting up and initiating safe and effective operation of the **Belmont® Rapid Infuser RI-2**. To change screens' language, select language at start-up or go to Chapter 4 "LANGUAGE SETUP" to setup your preferred language.



#### Warnings

- Use dedicated circuit breaker to avoid risk of supply interruption and for proper function of The Belmont Rapid Infuser RI-2. The Belmont draws maximum current under normal operating conditions and should be the only device operating on the circuit breaker.
- Do not use with pressure infusers or "bag squeezers". The system pump provides adequate pressure to infuse fluid.
- Do not use this product in the presence of flammable anesthetics.
- Do not use this product in an Oxygen rich environment.
- Do not use this product in the presence of Nitrous Oxide.
- The Belmont Rapid Infuser RI-2 should not be left unattended while in operation.
- Disposable set is for single patient use only. Do not reuse.
- Inspect and make certain that the patient line is completely primed and free of air. Any air bubbles after the valve wand in the patient line must be removed before the procedure can safely continue.
- Once the door is opened, all safety features of the system may be bypassed. Clamp off the patient line to ensure that air is not allowed to enter the patient prior to opening the door to the RI-2.
- Do not infuse blood that is in the disposable set when over temperature condition occurs. Red cells that have been subjected to high temperature may not be safe to infuse.
- Do not access SERVICE mode to adjust settings while the instrument is connected to patient.
- Excessive or prolonged recirculation may damage red blood cells by exposing them repeatedly to the rollers inside the pump head.
- Practice standard precautions when handling blood products. Treat all blood as if it were infected and clean up all spills immediately.
- Medical Electrical Equipment needs special precautions regarding EMC and needs to be installed and put into service according to the Electromagnetic Compatibility (EMC) information provided in the accompanying documents.
- Portable and Mobile RF Communications Equipment can affect Medical Electrical Equipment.

## Chapter 2: Operation



### Cautions

- If an IV pole is used, check that the system is securely clamped to the IV pole and will not tip over.
- Do not pressurize the reservoir.
- Do not apply a vacuum to the reservoir.
- Ensure the tubing and the reservoir and the interlock block is not bent, kinked, or pulled too tight.
- Immediately wipe any spills from the device.
- Prime the main system with solutions compatible with blood products. Do not prime with blood or blood products.
- A dedicated intravenous access site should be used for infusing blood components and solutions compatible with blood per AABB guidelines.
- Replace reservoir chamber or disposable set if the filter becomes clogged. If it becomes occluded the fluid sensor will activate, an audible alarm will sound, a message "Fluid Out, Check inlet tubing and Filter. Add more fluid" will appear and the pump will stop.
- Excessive or prolonged recirculation may damage red blood cells by exposing them repeatedly to the rollers inside the pump head.
- Battery operation should be used only briefly or at very low flow rates because there is no heating.
- With fluid in the disposable set and the system not powered on, keep the patient line clamped closed when opening the door to prevent uncontrolled fluid flow.
- Do not infuse blood that is in the disposable set when over temperature condition occurs. Red cells that have been subjected to high temperature may not be safe to infuse.
- Turn the system to OFF and unplug the power cord before cleaning to avoid electric shock.

## Chapter 2: Operation

### Compatible Fluids

Solution	Description	Compatible?
Anticoagulated whole blood that is processed & washed through a cell saver device		YES
FFP	Fresh Frozen Plasma	YES
RBCs	Red Blood Cells	YES
NS	0.9% NaCl	YES
Albumin 5%		YES
Hydroxyethyl Starch (HES)	Hetastarch in 0.9% Saline	YES
Normosol	Electrolytes in H <sub>2</sub> O	YES
Plasma-Lyte A		YES
Colloids	This is a broad-spectrum term	
Sodium Bicarbonate Solutions		NO
½ NS	0.45% NaCl	NO
3% NS	3% NaCl	NO
Platelets	Should not be diluted, stick to tubing	NO
Cryoprecipitate	Should not be diluted	NO
Calcium containing Solutions	Ca	NO
Lactated Ringer's Solution	K, Na, Cl, Ca, Lactate	NO
Ringer's Solution	K, Na, Cl, Ca, Lactate	NO
Hartmann's Solution	K, Na, Cl, Ca, Lactate	NO
Hextend	Hetastarch in Lactated Ringer's	NO
8% Amino Acids		NO
Intralipids 10%		NO
Intralipids 20%		NO
D5W	5% Dextrose in Water	NO
D10W	10% Dextrose in Water	NO
D20W	20% Dextrose in Water	NO
D50W	50% Dextrose in Water	NO
D5 ¼ NS	5% Dextrose 0.2% NaCl	NO
D5 ½ NS	5% Dextrose 0.45% NaCl	NO
D5NS	5% Dextrose 0.9% NaCl	NO
D10NS	10% Dextrose 0.9% NaCl	NO
10% Dextran in 5% Dextrose		NO
10% Dextran 40 in 0.9% NS		NO
5% Alcohol in 5% Dextrose		NO
D5 LR	5% Dextrose in Lactated Ringer's	NO
D10 LR	10% Dextrose in Lactated Ringer's	NO
Glucose		NO



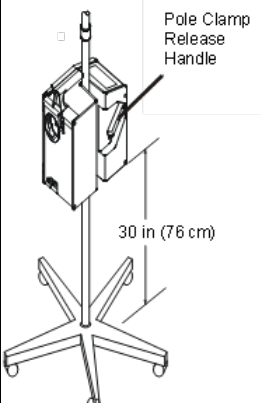
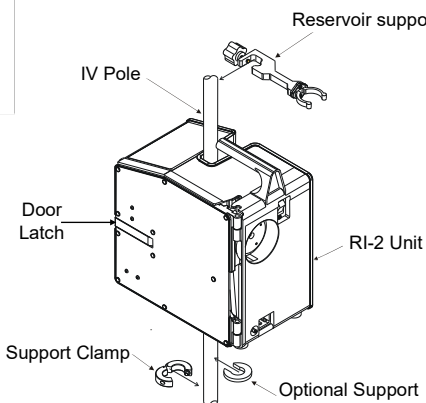

## Step-By-Step Operating Procedures

SET-UP	
<p><b>Inspecting the System</b></p> <ul style="list-style-type: none"> <li>• Power cord</li> <li>• Reservoir Support</li> <li>• Disposable Set</li> <li>• Large Reservoir and holder, if needed</li> </ul>	<p>Inspect the system to ensure that you have all necessary components.</p> <p>Ensure that circuit breaker is easily accessible to turn off in an emergency situation.</p> <p>Use only supplied power cord.</p>
<p><b>IV Pole Mounting</b></p> <ul style="list-style-type: none"> <li>• IV Pole: 5 wheel, maximum diameter 1 1/4"</li> <li>• Install the Support Assembly 30" from the ground, if not already installed.</li> <li>• Mount the Belmont® Rapid Infuser RI-2 on the IV Pole above the Support Assembly</li> <li>• Install the Reservoir Support app. 9" above the top of the system</li> </ul> <p><b>Disclaimer: the IV pole is not required for use; it is not considered a critical-detachable component and ordering an IV pole from Belmont is optional.</b></p> <p><b>CAUTION:</b></p> <p><b>If an IV Pole is used, check that the system is securely clamped to the IV pole and will not tip over</b></p>	<div style="display: flex; justify-content: space-around;">   </div> <ol style="list-style-type: none"> <li>1. Install the support assembly (support clamp and washer) approximately 30" from the ground.             <ul style="list-style-type: none"> <li>• While holding clamp closed, loosen the screw to open up the clamp. Install clamp on the IV pole, holding clamp close and tighten screw using the supplied 3/16 Allen wrench.</li> <li>• Optional: Snap the plastic washer onto the IV pole above the support clamp. Not all IV Poles are supplied with the plastic washer as it is optional and does not affect functionality.</li> </ul> </li> <li>2. Lift up on the "Pole Clamp Release Handle" to open. Mount the system onto the IV pole, above the support assembly, by pushing down on the pole clamp release handle. Check that the system is locked in place before proceeding.</li> <li>3. Clamp the reservoir support onto the IV pole approximately 9" above the Belmont® Rapid Infuser RI-2.             <ul style="list-style-type: none"> <li>• Make certain that there is nothing obstructing the air vents at the bottom of the system.</li> </ul> </li> </ol>
<p><b>Device Set-up without IV Pole</b></p>	<ol style="list-style-type: none"> <li>1. Ensure all 4 feet are securely attached to the device.</li> <li>2. Place device on a sturdy, flat surface that will not obstruct the fan guards.</li> <li>3. Ensure there is place to hang fluids bags above the reservoir to avoid kinked or twisted tubing.</li> </ol>

## Chapter 2: Operation

### Installing the Disposable Set

Store the disposable set, in the sealed original packaging, in a dry well-ventilated area free from exposure to chemical vapors.

It is recommended to load and prime the disposable set just prior to the procedure.

**WARNING: The disposable set is for single patient use only. Do not reuse.**

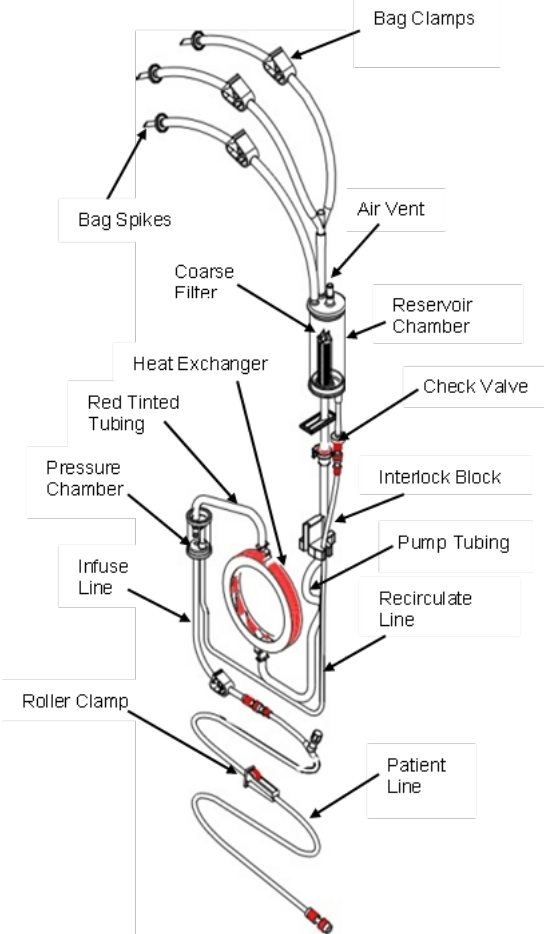

3-Spike Disposable set with key components



1. Snap reservoir chamber into the reservoir support clamp.
2. Open the door. Insert heat exchanger with red arrow pointing up (**Red tinted tubing** to red stripe on unit.)

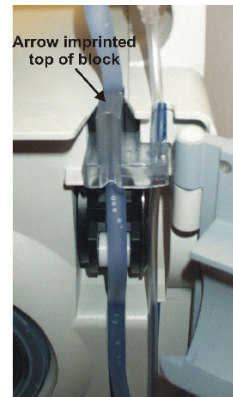

3. Firmly position the interlock block into the fluid out detector.
4. Guide the curved piece of pump tubing (**Blue tinted tubing**) over the pump head. Check that the thinner recirculate line is in the groove to the right.

**Do not kink or twist the tubing**

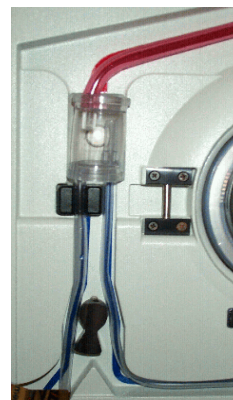

5. Place the pressure chamber into the pressure chamber well. Firmly insert the wider infuse line into the air detector and to the left of valve wand.

**Do not apply excessive pressure to the pressure transducer. The pressure transducer can be damaged with excessive force. Do not use the system if the pressure transducer is damaged.**

6. Place the thinner recirculate line to the right of the air detector, and to the right of the valve wand.
7. Close and latch the door. Make certain the pump tubing is not caught. Connect the patient line.

## Chapter 2: Operation

### Installing the Optional Large Reservoir

- Install large reservoir holder
- Install large reservoir



#### CAUTION:

**Do not pressurize the reservoir**

**Do not apply a vacuum to the reservoir**

**Ensure the tubing between the reservoir and the interlock block is not bent, kinked, or pulled too tight. Adjustment of the reservoir or reservoir holder may be needed.**

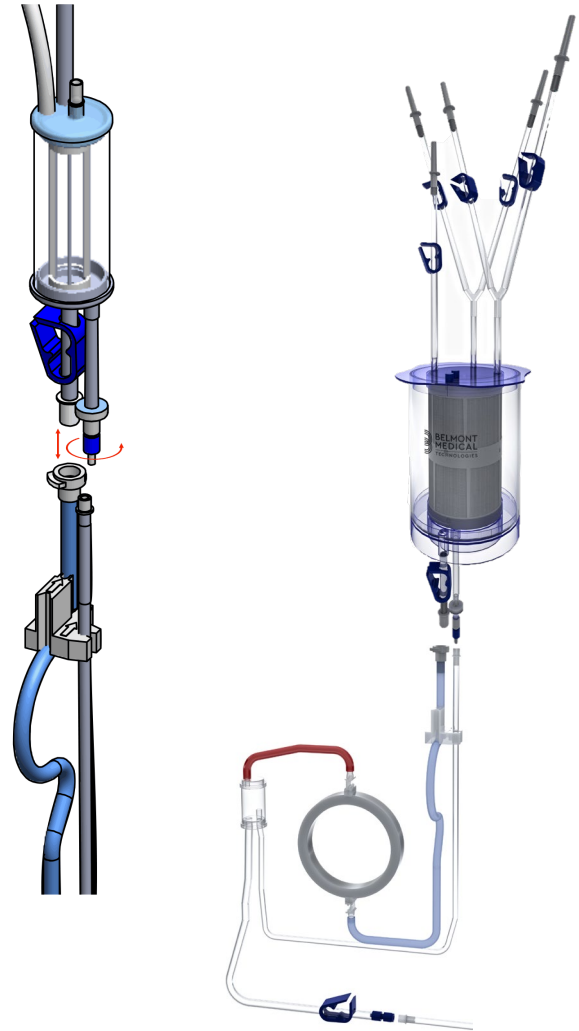

1. Using aseptic techniques, remove the reservoir chamber from the 3-Spike disposable set by disconnecting the luer connectors.
  - Disconnect the larger pump tubing by pressing in the luer lock tab and pulling out the connector.
  - Disconnect the thinner recirculate line by unscrewing the connector.
2. Attach the large reservoir holder onto the IV pole, if used, and place the reservoir into the holder.
3. Assemble the large reservoir using aseptic techniques by attaching the three fluid supply tails onto the top of the reservoir.
4. Connect the large reservoir to the fitting of the 3-Spike disposable set.
5. Adjust the reservoir holder to make sure that the two connection leads underneath the reservoir are not stretched or kinked.  
Stretched or kinked connection leads can cause flow restrictions and frequent Fluid Out alarms.



## Chapter 2: Operation

### Powering On the System

- Check that the detachable power cable is securely seated in the main power receptacle.
- Check that the moisture guard is flush against the Rapid Infuser if present.
- Plug the system power cord into a grounded, 3-prong, 20 Amp, AC receptacle (120V device) or into appropriate grounded, 3-prong, minimum 10 Amp, AC receptacle (230V device) **on a dedicated circuit breaker.**
- Do not use an adaptor for ungrounded outlets.
- **Ensure that circuit breaker is easily accessible to turn off in an emergency situation.**

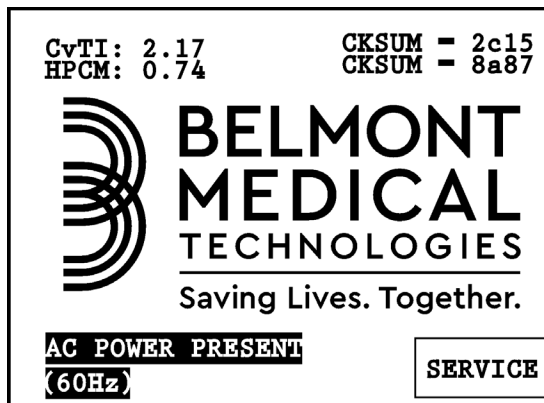

Power-Up Screen

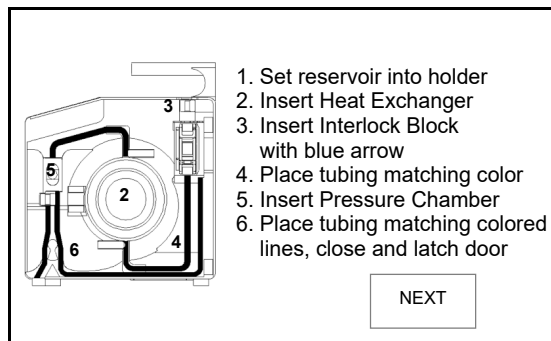

Installation Screen

1. Plug system into a dedicated AC power source (breaker).
2. Turn power on by firmly pressing the circuit breaker to the ON position. The system will perform a self-check to check the integrity of system parameters.
3. Ensure AC POWER PRESENT appears at the logo screen when the system first powers up. Check the power cord and AC receptacle connections if the statement does not appear.
4. PRIME screen will appear.
5. Press NEXT to go to the PRIME screen.

- If screen language is not your preferred language, turn power off and back on.
- Press SERVICE to go to CALIBRATION/SETUP screen.
- Press LANG SETUP → choose your preferred language → NEXT → EXIT SERVICE.
- If you turn power ON without the disposable set, INSTALLATION screen appears.
- Open the door and follow instructions on screen to install the disposable set.
- Close the door. PRIME screen will automatically appear.

**WARNING: The RI-2 should not be left unattended while in operation.**

**WARNING: Use a dedicated circuit breaker to avoid risk of supply interruption and for proper function of The Belmont Rapid Infuser RI-2. The Belmont draws maximum current under normal operating conditions and should be the only device operating on the circuit breaker.**

## Chapter 2: Operation

### Installing Fluid Bag

Install solution compatible with blood for the main system prime.

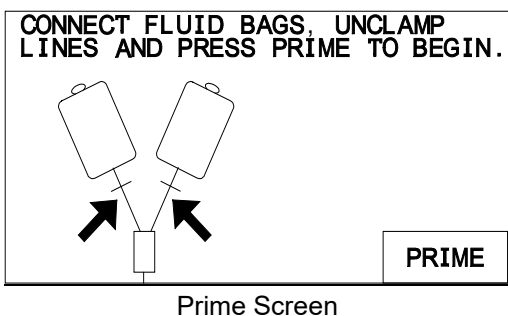

1. Hang fluid bag(s) on the IV pole, if used.
2. Completely close bag clamps, remove the bag spike cap(s). Spike fluid bag(s), piercing it fully to ensure that fluids flow freely.
3. Open bag clamps.
  - When hanging the fluid bag above the machine, the pump tubing that is seated in the fluid out detector should not be stretched. Stretching the pump tubing may cause false Fluid Out alarms.
  - The recirculate line must not be kinked or restricted.

**The Belmont® Rapid Infuser RI-2, is not for use in warming platelets, cryo-precipitates, granulocyte suspensions, pharmaceutical agents, unprocessed whole blood.**

**DO NOT combine any substances containing calcium with blood products. This will cause clotting and occlusion of the unit and possible overheating occurrence. Calcium containing solutions, such as Lactated Ringer's solution, Hartmann's solution, dextrose in water, and hypotonic sodium chloride solutions should not be added to blood components per AABB (American Association of Blood Banks). See the compatible fluids list on page 10.**

**Caution: Prime the main system with solutions compatible with blood products. Do NOT prime with blood or blood products.**

### Priming the Main System

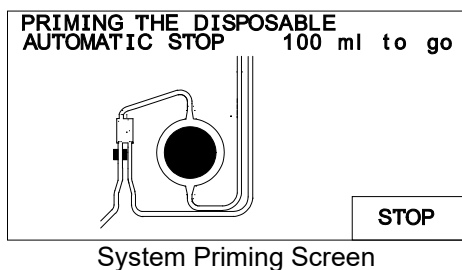

**CAUTION:**  
Immediately wipe any spills from the device

1. Press PRIME to recirculate 100 ml of fluid at 500 ml/min to remove air and fill the main system with fluid.
2. The prime volume, 100 ml, countdown is displayed on the screen. Priming will stop automatically when countdown reaches 0 ml. SYSTEM PRIMED screen appears.
  - If after 30 seconds the prime volume remains at 100 ml, the system will stop, alarm and instruct the user to unclamp the lines and resume prime.
  - If prime has to be stopped, press STOP. The prime volume countdown will remain on the screen. Press RESUME PRIME to continue prime.

## Chapter 2: Operation

### Priming the Patient Line

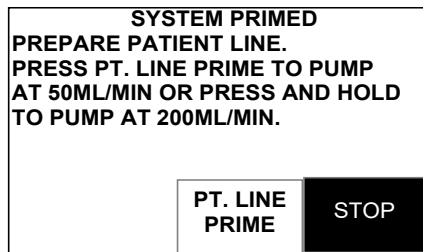

System Primed Screen

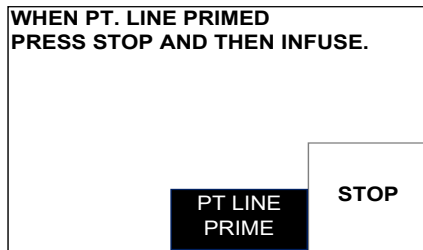

Patient Line Primed Screen

To remove air from the patient line:

1. Open the roller clamp and remove the luer cap from the patient line.
2. Press PT. LINE PRIME
  - Press once, prime at 50 ml/min. Press and hold, prime at 200 ml/min.
3. Press STOP after no air remains in patient line.

**WARNING:** Inspect and make certain that the patient line is completely primed and free of air. Any air bubbles after the valve wand in the patient line must be removed before the procedure can safely continue.

### Connecting to the Patient

Match infusion set to flow rate and fluid type, see chart.

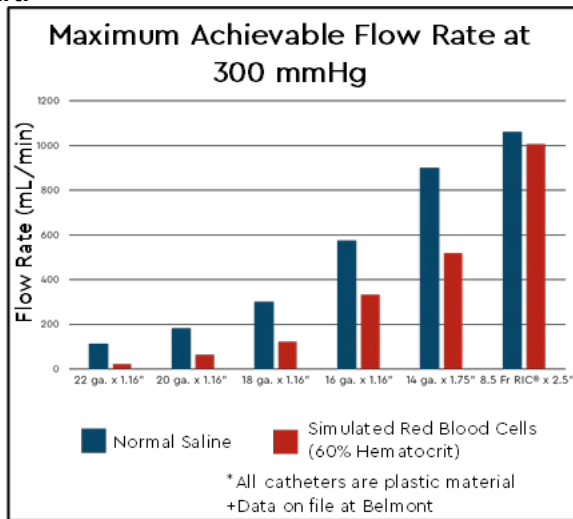

1. Select an appropriate cannula size for desired flow rate.
2. Using aseptic technique, make patient connection without entrapping air.

**CAUTION:** A dedicated intravenous access site should be used for infusing blood components and solutions compatible with blood per AABB guidelines.

## Chapter 2: Operation

### Initiating Infusion

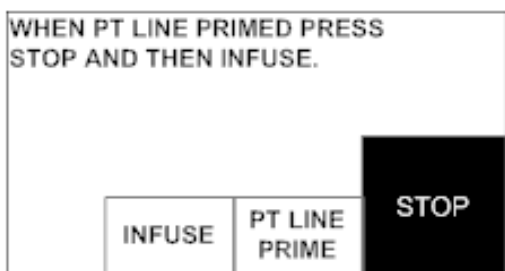

Patient Line Primed and Infuse Screen

SET RATE = 500 ml/min	INFUSING
ACTUAL RATE = 500 ml/min	T = 37.3°C
VOL = 16.2 L	P = 125 mmHg
INFUSE RATE ▲ 500 ml/min	BOLUS 200 ml
INFUSE RATE ▼ 500 ml/min	RECIRC
STOP	

Infuse Screen

1. Press INFUSE to start infusing at 10 ml/min.
2. Press 500 ML/MIN key to infuse at 500 ml/min or adjust flow rate, as needed, by pressing INFUSE RATE ▲/INFUSE RATE ▼ key (increase/decrease by 10 ml/min).

**Do not mix solutions containing calcium such as Lactated Ringer's, or Hartmann's solution with citrated blood products. See the compatible fluids list on page 10.**

**Use only anticoagulated blood products.**

### Maintaining Infusion

SET RATE = 500 ml/min	INFUSING
ACTUAL RATE = 500 ml/min	T = 37.3°C
VOL = 16.2 L	P = 125 mmHg
INFUSE RATE ▲ 500 ml/min	BOLUS 200 ml
INFUSE RATE ▼ 500 ml/min	RECIRC
STOP	

Infuse Screen

Routinely check patient and system parameters, on screen. Respond to and correct system alarms.

Disposable set should be replaced after 24hours of use.

#### CAUTION:

**Replace reservoir chamber or disposable set if the filter becomes clogged. If it becomes occluded the fluid out sensor will activate, an audible alarm will sound, a message "Fluid Out, Check inlet tubing and Filter. Add more fluid" will appear and the pump will stop.**

## Chapter 2: Operation

### Pressure Control

Regulate the pump speed to keep line pressure under the user-set pressure limit.

SET RATE = 500 ml/min	Infusing-Pressure Control Press Set Rate to match Actual Rate 		
ACTUAL RATE = 140 ml/min	T = 37.3°C		
VOL = 16.2 L	P = 298 mmHg		
INFUSE RATE ▲	500 ml/min RATE	BOLUS 200 ml	STOP
INFUSE RATE ▼		RECIRC	

Pressure Control Screen

The pressure limit is set at the factory to the maximum limit of 300 mmHg. Limit can be changed, see Chapter 4, page 36.

While the system is under pressure control, the system displays “Infusing-Pressure Control. Press Set Rate to match Actual Rate” message, pressure status line flashes and a tone beeps at 10 second interval.

Pressure control may be automatically initiated due mainly to the small orifice of the infusion set or any occlusions in the line.

To eliminate the pressure control, press SET RATE key to match the actual rate that the system is able to maintain without alarm or use a proper size cannula for the desired flow rate and fluid type. **See chart to match infusion set to flow rate and fluid type**, page 19.

### Automatic Air Purging

SET RATE = 500 ml/min	REMOVING AIR 		
ACTUAL RATE = 500 ml/min	T = 37.3°C		
VOL = 16.2 L	P = 125 mmHg		
INFUSE RATE ▲	500 ml/min RATE	BOLUS 200 ml	STOP
INFUSE RATE ▼		RECIRC	

Automatic Air Purging Screen

After every 500 ml of fluid infused, the system automatically purges air from the system by closing the infusion line and opening the recirculation line for a few seconds.

The recirculate rate is temporarily set to 500 ml/min, if the flow rate is at or below 500 ml/min, and at the actual flow rate, if the flow rate is above 500 ml/min.

The RATE status line displays REMOVING AIR during this process. The volume readout (VOL) remains unchanged during automatic air purging and resumes counting when infusion resumes.

When infusion resumes, the system returns to the previously set rate.

### Bolus Infusion (Infuse a Fixed Volume)

SET RATE = 200 ml/min	INFUSING 		
ACTUAL RATE = 200 ml/min	T = 37.3°C		
BOL = 200 ml	P = 125 mmHg		
INFUSE RATE ▲	500 ml/min RATE	200 ml 10 ml	STOP
INFUSE RATE ▼		RECIRC	

Bolus Screen



Deliver fixed volume, factory set to 200 ml, at a rate of 200 ml/min.

To change the flow rate during the bolus infusion, press the INFUSE RATE ▲ or INFUSE RATE ▼ or 500 ml/min RATE key.

Bolus volume can be changed in the Parameters Set-Up screen (Chapter 4, page 36) or by pressing and holding the BOLUS key in the Infuse screen. The new bolus volume will appear in the VOL (volume) status line with the prefix of BOL (bolus). Releasing the Bolus key will start the infusion.

Two sets of numbers are displayed within the BOLUS key space. The top number is the bolus value set and the bottom number is the volume pumped and is counting up from 0 to the volume set on the key. At the end of the bolus volume, the system beeps and returns to the previously selected flow rate if the previous rate was 50 ml/min or lower. If the previous rate was higher than 50 ml/min, the flow rate will be set to 50 ml/min.

## Chapter 2: Operation

<p><b>Recirculation</b></p> <table border="1" data-bbox="220 243 691 598"> <tr> <td>SET RATE</td> <td>= 200 ml/min</td> <td colspan="2">RECIRCULATING </td> </tr> <tr> <td>ACTUAL RATE</td> <td>= 200 ml/min</td> <td colspan="2">T = 37.3°C</td> </tr> <tr> <td colspan="2">VOL = 16.2 L</td> <td colspan="2">P = 125 mmHg</td> </tr> <tr> <td>INFUSE RATE ▲</td> <td rowspan="2">500 ml/min RATE</td> <td>BOLUS 200 ml</td> <td rowspan="2">STOP</td> </tr> <tr> <td>INFUSE RATE ▼</td> <td><b>RECIRC</b></td> </tr> </table> <p style="text-align: center;">Recirculation Screen</p>	SET RATE	= 200 ml/min	RECIRCULATING 		ACTUAL RATE	= 200 ml/min	T = 37.3°C		VOL = 16.2 L		P = 125 mmHg		INFUSE RATE ▲	500 ml/min RATE	BOLUS 200 ml	STOP	INFUSE RATE ▼	<b>RECIRC</b>	<p>Recirculate fluid, warm, and remove air in the main system at a preset rate of 200 ml/min. Recirculation automatically stops and beeps after 5 minutes.</p> <p><b>Caution:</b> Excessive or prolonged recirculation may damage red blood cells by exposing them repeatedly to the rollers inside the pump head.</p>
SET RATE	= 200 ml/min	RECIRCULATING 																	
ACTUAL RATE	= 200 ml/min	T = 37.3°C																	
VOL = 16.2 L		P = 125 mmHg																	
INFUSE RATE ▲	500 ml/min RATE	BOLUS 200 ml	STOP																
INFUSE RATE ▼		<b>RECIRC</b>																	
<p><b>Stop</b></p>	<p>Temporarily halts pumping and heating. Status display continues to be active.</p>																		

## Chapter 2: Operation

### Battery Operation

SET RATE = 50 ml/min	INFUSING 		
ACTUAL RATE = 50 ml/min	BATTERY NO HEATING		
VOL = 16.2 L	P = 125 mmHg		
INFUSE RATE ▲	50 ml/min RATE	BOLUS 200 ml	STOP
INFUSE RATE ▼		RECIRC	

Battery Operation Screen

**CAUTION:**  
Battery operation should be used only briefly or at very low flow rates because there is no heating.

1. Press RECIRC key to preheat fluid in the reservoir chamber.
2. Unplug the system from the wall outlet. The status line that displays temperature will be flashing BATTERY NO HEATING to indicate the system is now in battery mode, the maximum flow rate is 50 ml/min, and heating is suspended.
3. Adjust the flow rate by pressing INFUSE RATE ▲ or INFUSE RATE ▼ or press 50 ML/MIN to immediately set the infuse rate to the maximum rate of 50 ml/min.
4. When the system is plugged back to the AC outlet, the flow rate stays at 50 ml/min if the previous flow rate was greater than 50 ml/min. The system will return to the previous flow rate if the previous rate was 50 ml/min or lower.
5. The normal running time in battery is at least 30 minutes.

### Low Battery

SET RATE = 50 ml/min	INFUSING 		
ACTUAL RATE = 50 ml/min	BATTERY LOW NO HEATING		
VOL = 5075 ml	P = 122 mmHg		
INFUSE RATE ▲	50 ml/min RATE	BOLUS 100ml	STOP
INFUSE RATE ▼		RECIRC	

Battery Operation Screen

### LOW BATTERY

When the battery runs low, the system will display BATTERY LOW message and a tone will occur every 10 seconds. The system should be plugged into an AC outlet to continue operation and charge the battery.

The normal recharge time is 8 hours.

### Accidental Power Off

SET RATE = 0 ml/min		
ACTUAL RATE = 0 ml/min	T = 37.3°C	
VOL = 16.2 L	P = 125 mmHg	
PLEASE STOP THE PUMP BEFORE TURNING THE POWER OFF. TURN THE CIRCUIT BREAKER BACK ON.		POWER OFF

Accidental Power Off Screen

If the circuit breaker was turned to the OFF position while the system is pumping, the system will stop pumping, and alarm. This message is to protect the system from being accidentally powered down during a procedure.

To power off the system, press POWER OFF key, on screen.

To continue with the procedure, turn the circuit breaker back to the ON position and resume operation.

## Chapter 2: Operation

<p><b>End of Procedure</b></p> <p><b>CAUTION:</b> With fluid in the disposable set and the system not powered on, keep the patient line clamped closed when opening the door to prevent uncontrolled fluid flow.</p> <p>Note: The residual fluid volume is less than 100mL when the reservoir is fully empty.</p>	<ol style="list-style-type: none"><li>1. If the pump is on, press STOP.</li><li>2. Clamp off the patient line and bag spikes.</li><li>3. Turn the system OFF, using the circuit breaker.</li><li>4. Open the door and remove the disposable set from the system. Practice standard hospital policy when handling and disposing the bio-hazardous materials.</li><li>5. Follow the cleaning procedures outlined in Chapter 4, pages 38 - 41 to clean and disinfect the system.</li></ol>
<p><b>System Error</b></p> <p>In the event the system is not operational during a procedure and troubleshooting does not resolve the issue, the device should be disconnected from the patient and fluid should be infused manually with alternate equipment or gravity.</p> <p><b>WARNING:</b> Once the door is opened, all safety features of the system may be bypassed. Clamp off the patient line to ensure that air is not allowed to enter the patient prior to opening the door to the RI-2.</p>	<ol style="list-style-type: none"><li>1. Close the blue pinch clamp to close the patient line clamp.</li><li>2. Follow the steps outlined above under END OF PROCEDURE.</li><li>3. If needed, continue infusion using alternate device(s). Follow all applicable Instructions For Use for alternate devices.</li><li>4. Report any incidents to Belmont Medical Technologies.</li></ol>



## Chapter 3: Alarms and Troubleshooting Guide

### Introduction

This chapter describes possible causes for alarm messages with suggestions for corrective actions. When the Belmont® Rapid Infuser RI-2 recognizes a situation that is compromising effective infusing, it immediately stops pumping and heating, and moves the valve wand into the recirculate position. It then displays an alarm message, provides instructions for corrective measure, and sounds an audible alarm. The device operator should be standing in front of the device when there is an alarm condition such that they can properly read the display.

This audible operational alarm consists of a series of ten beeps that repeat every 2.5 seconds. The green light to the top-right of the display will also turn red to signal a high-priority alarm condition. To mute an alarm and return to normal operation, select the MUTE key on the alarm message screen and follow the on-screen instructions. When the MUTE key has been selected, it will appear to be highlighted on the display screen and the mute symbol below will appear. The alarm conditions will persist until the alarm condition is resolved.



All alarms are considered high-priority technical alarms except for the Battery Low message. During battery low, a visual alarm will appear as noted below and has a different audible alert, a beep every ten seconds.

Information Signals		
DISPLAYED MESSAGE	POSSIBLE CONDITION	OPERATOR ACTION
LOW BATTERY	Battery voltage is too low	<p>Plug the system into an AC outlet to continue operation and recharge the battery. Allow at least 8 hours to fully charge the battery.</p> <p>If LOW BATTERY displayed while the system is connected to AC power, one of the components may be defective. Service machine.</p> <p>If battery is completely discharged, turn the AC power OFF, plug the system into an AC outlet to recharge the battery.  <b>Wait for at least 30 seconds before turning the system ON.</b></p>
Infusing-Pressure Control. Press Set Rate to match Actual Rate	Set Rate differs from Actual Rate due to high pressures generated in line	Press SET RATE to bring Set Rate into range with the Actual Rate to decrease the in line pressure.

## Chapter 3: Alarms and Troubleshooting Guide

### Operational Alarms

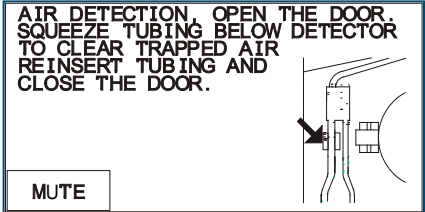
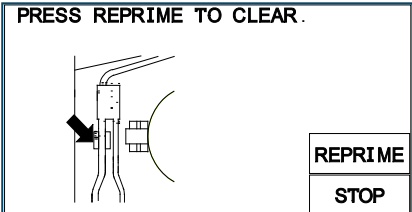
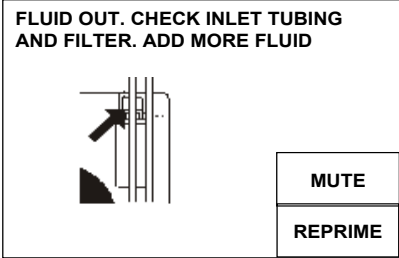
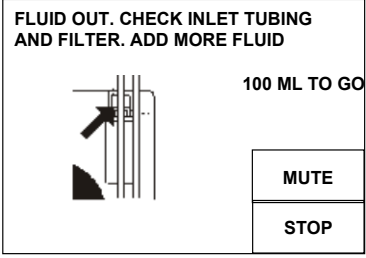
ALARM MESSAGE	POSSIBLE CONDITION	OPERATOR ACTION
<p><b>Air Detection</b></p>  <p>AIR DETECTION. OPEN THE DOOR. SQUEEZE TUBING BELOW DETECTOR TO CLEAR TRAPPED AIR. REINSERT TUBING AND CLOSE THE DOOR.</p> <p>MUTE</p> <p>Air Detection Alarm Message Screen</p>  <p>PRESS REPRIME TO CLEAR.</p> <p>REPRIME</p> <p>STOP</p> <p>Reprime Screen</p>	<p>Air in the line.</p> <p>Tubing in the air detection sensor is not seated firmly in the detector.</p> <p>Leak in the disposable.</p> <p>Air detector sensor dirty.</p> <p>Air detector electronics defective.</p>	<p>Open the door to silence the alarm.</p> <p>Check for air bubbles and possible leaks.</p> <p>Squeeze the tubing directly below air detector to clear any trapped air out of the sensor. There should be no trapped air remaining within the air detector.</p> <p>Check the air detector and make certain that it is clean and nothing is obstructing the sensor.</p> <p>Reseat the tubing in the air detector and make certain that it is seated firmly in the sensor.</p> <p>Press REPRIME to reprime main system. If the system does not complete the reprime because the filter in the reservoir chamber is clogged, replace the reservoir chamber or the disposable set and reprime. The system will resume infusion upon completion of the reprime.</p> <p>Power off and service the machine if error persists.</p>
<p><b>Fluid Out</b></p>  <p>FLUID OUT. CHECK INLET TUBING AND FILTER. ADD MORE FLUID</p> <p>MUTE</p> <p>REPRIME</p> <p>Fluid Out Alarm Screen</p>  <p>FLUID OUT. CHECK INLET TUBING AND FILTER. ADD MORE FLUID</p> <p>100 ML TO GO</p> <p>MUTE</p> <p>STOP</p> <p>Fluid Out Message after Pressing REPRIME Screen</p>	<p>Out of fluid.</p> <p>Bag clamps not fully opened or fully spiked.</p> <p>Tubing in the Fluid out sensor is not seated firmly in the detector, or tubing is stretched or pulls away from the sensor, due to vacuum in the line.</p> <p>Clogged air vent filter or coarse blood filter.</p> <p>Reservoir or recirculate line is obstructed.</p> <p>Detector electronics defective.</p>	<p>Press MUTE to silence the Alarm.</p> <p>If out of fluid, add additional fluid and press REPRIME.</p> <p>Open bag clamp or fully spike the bag.</p> <p>Reseat the tubing in the fluid out detector and make certain that it is seated firmly in the sensor.</p> <p>If the reservoir chamber stays empty during reprime, the air vent filter, on top of the reservoir chamber, may be clogged. In this case, pierce the fluid bag(s) with bag spikes and fully open clamps to allow the air in the reservoir chamber to escape into fluid bag(s) and allow fluid to fill the reservoir chamber.</p> <p>High amounts of particulates in the blood may clog the coarse blood filter in the reservoir chamber. Replace reservoir chamber or disposable if it is clogged.</p> <p>Power off and service the machine if error persists.</p>

### Chapter 3: Alarms and Troubleshooting Guide

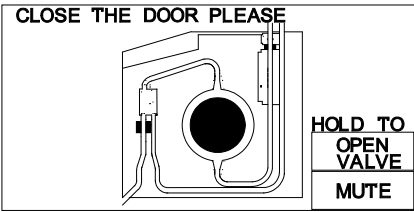
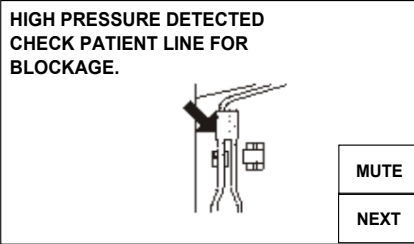
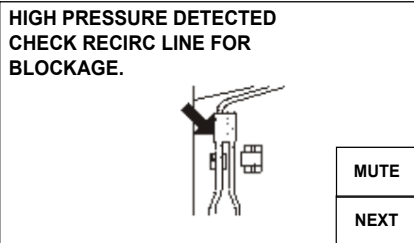
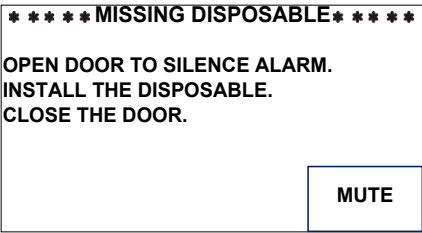
ALARM MESSAGE	POSSIBLE CONDITION	OPERATOR ACTION
<p><b>Door Open</b></p>  <p>Door Open Alarm Screen</p>	<p>The door is open.</p> <p>No magnet in the door latch.</p>	<p>Close the door to silence the alarm and resume.</p> <p>Check magnet in the door latch.</p> <p>If the door is opened while the system is pumping, the system will immediately stop heating and pumping. The valve moves to the recirculate position and an audible alarm sounds.</p>
<p><b>High Pressure</b></p>   <p>High Pressure Alarm Screen</p>	<p>Patient line is blocked.</p> <p>Recirculate line is blocked.</p> <p>Infusion site is not well placed.</p> <p>The catheter bore size is too small.</p> <p>Pressure limit setting is set too low.</p>	<p>Make certain that the flow path is not blocked.</p> <p>Check that the recirculate line is not obstructed.</p> <p>Check that the infusion site is well placed and use the appropriate infusion set recommended in the guide, <u>Match the Infusion Set to Flow Rate and Fluid Type</u> on page 19.</p> <p>Increase pressure limit setting.</p> <p>Press NEXT to silence the alarm and resume.</p> <p>Check functionality of the pressure transducer by gently pressing the transducer. Pressure reading on screen should change. If not, it is defective, service machine.</p>
<p><b>Missing Disposable</b></p>  <p>Missing Disposable Screen</p>	<p>No disposable set in the unit.</p>	<p>Properly install disposable.</p> <p>Press NEXT to resume.</p>

## Chapter 3: Alarms and Troubleshooting Guide

### Heating Alarms

Heating alarms which may occur are:

ALARM MESSAGE	POSSIBLE CONDITION	OPERATOR ACTION
<p><b>System Error #101</b></p> <p>CHECK TEMPERATURE PROBES FOR BLOCKAGE. CLEAN WINDOWS. PRESS RETRY TO CONTINUE. SERVICE MACHINE IF ERROR PERSISTS.</p>	<p>Heater Fault</p> <p>Wet, dirty, or blocked disposable set windows.</p> <p>Wet, dirty, or blocked IR probe.</p> <p>IR probe failure.</p> <p>System was turned on without AC power present.</p>	<p>Check disposable set and flow path for occlusions. Make certain the windows on the disposable set and the IR probes are clean and dry. Clean surfaces with moistened soft cloth if necessary. Dry off surfaces before continuing.</p> <p>Press RETRY to continue.</p> <p>If system was started without AC power present: turn device off. Plug device in. Power on the device and ensure the startup screen reads AC power present</p> <p>Power off and service machine if error persists.</p>
<p><b>System Error #102</b></p> <p>INFUSATE OVER TEMPERATURE. DISCARD DISPOSABLE AND BLOOD. RESTART SYSTEM WITH A NEW DISPOSABLE. SERVICE MACHINE IF ERROR PERSISTS.</p>	<p>Over Temperature</p> <p>Fluid supply is over the temperature limit</p> <p>Temperature probes are wet, dirty, or blocked.</p> <p>Restricted flow or out of fluid.</p>	<p>Check disposable set and flow path for occlusions. Make certain the windows on the disposable set and the IR probes are clean and dry. Clean surfaces with moistened soft cloth if necessary. Dry off surfaces before continuing.</p> <p>Make sure bag clamps are open and flow is unimpeded. Make sure that the filter is not clogged. Add more fluid, if fluid out.</p> <p>Clamp off the bag spikes and patient line and remove disposable. Power off and restart system with a new disposable.</p> <p>Service machine if the problem persists.</p> <p><b>WARNING: Do not infuse blood that is in the disposable set when over temperature condition occurs. Red cells that have been subjected to high temperature may not be safe to infuse.</b></p>

## Chapter 3: Alarms and Troubleshooting Guide

### Hardware Alarms

ALARM MESSAGE	POSSIBLE CONDITION	OPERATOR ACTION
<b>System Error #201</b> POWER OFF AND RESTART. SERVICE MACHINE IF ERROR PERSISTS.	Air detector failure	Power off and restart. Service machine if error persists.
<b>System Error #202</b> POWER OFF AND RESTART. SERVICE MACHINE IF ERROR PERSISTS.	Fluid out detector failure	Power off and restart. Service machine if error persists.
<b>System Error #203</b> PRESS RETRY TO CONTINUE. SERVICE MACHINE IF ERROR PERSISTS.	Heater Fault  Excessive AC power line noise or internal failure	Press RETRY to try again.  Power off and restart. Service machine if error persists.
<b>System Error #204</b> POWER OFF AND RESTART. SERVICE MACHINE IF ERROR PERSISTS.	Heater Feedback Fault  Heater power feedback sense coil open.  Power feedback circuit malfunction.	Power off and restart. Service machine if error persists.
<b>System Error #205</b> PRESS RETRY TO CONTINUE. SERVICE MACHINE IF ERROR PERSISTS.	Heater hardware fault	Press RETRY to try again.  Power off and restart. Service machine if error persists.
<b>System Error #206</b> CHECK FOR BLOCKED AIR INTAKE. WAIT FOR THE SYSEM TO COOL. SERVICE MACHINE IF ERROR PERSISTS.	Power driver module overheating	Make certain that the fan air vents at the bottom of the machine are not blocked.  Wait for unit to correct problem. Display will return to Infuse screen when the error clears.  Press MUTE to silence the alarm.  Power off and restart. Service machine if error persists.

### Chapter 3: Alarms and Troubleshooting Guide

ALARM MESSAGE	POSSIBLE CONDITION	OPERATOR ACTION
<p><b>System Error #207</b></p> <p>CHECK PUMP FOR BLOCKAGE. PRESS RETRY TO CONTINUE. SERVICE MACHINE IF ERROR PERSISTS.</p>	<p>Pump failure</p> <p>Pump tubing is installed incorrectly</p> <p>Pump speed feedback encoder failure.</p> <p>Pump runs out of control or not at all.</p>	<p>Check that pump tubing is seated on the pump head correctly.</p> <p>Check that pump turns freely and the pump head is clean.</p> <p>Press Retry to try again.</p> <p>Power off and restart. Service machine if error persists.</p>
<p><b>System Error #208</b></p> <p>CHECK VALVE FOR BLOCKAGE. POWER OFF AND RESTART. SERVICE MACHINE IF ERROR PERSISTS.</p>	<p>Valve failure</p> <p>Valve position sensor malfunction</p>	<p>Check that the valve is not blocked.</p> <p>Power off and restart. Service machine if error persists.</p> <p><b>CAUTION:</b></p> <p>Keep the patient line clamped closed when opening the door to prevent uncontrolled fluid flow.</p>
<p><b>System Error #209</b></p> <p>CHECK FOR BLOCKED AIR INTAKE. WAIT FOR THE SYSEM TO COOL. SERVICE MACHINE IF ERROR PERSISTS.</p>	<p>Board overheating</p> <p>Printed Circuit Board overheating</p>	<p>Make certain that the fan air vents at the bottom of the machine are not blocked.</p> <p>Wait for unit to correct problem. Display will return to Infuse screen when the error clears.</p> <p>Press MUTE to silence the alarm.</p> <p>Power off and restart. Service machine if error persists.</p>
<p><b>System Error #210</b></p> <p>POWER OFF AND RESTART. SERVICE MACHINE IF ERROR PERSISTS.</p>	<p>Internal computer malfunction</p>	<p>Power off and restart. Service machine if error persists.</p> <p><b>CAUTION:</b></p> <p><b>Keep the patient line clamped closed when opening the door to prevent uncontrolled fluid flow.</b></p>

## Chapter 3: Alarms and Troubleshooting Guide

### Troubleshooting Other Operational Difficulties

Problems may occur that are outside the surveillance system due to improper setup, faulty accessory equipment, or internal failure of a component. Table below describes several of these potential problems, the alarm that might be generated (if any), and the corrective actions to take.

ALARM MESSAGE	POSSIBLE CONDITION	OPERATOR ACTION
Battery No Heating	Power cord not plugged in AC power	Plug into AC receptacle; check power cord connection. Keep the system plugged in to charge the battery.
Dim display	Display brightness in Setup Routine has been turned down to the lowest brightness setting.	Increase display brightness in System Setup, Chapter 4, page 36.
Flow rate is slowing down or will not go at the set rate	The system is keeping the pressure in the line under the Pressure Limit by reducing the infusion rate.	Check and remove kinks or obstructions in the tubing. Use the appropriate infusion set recommended in the guide, Match the Infusion Set to Flow Rate and Fluid Type, Chapter 2, page 19. Increase flow by increasing the Pressure Limit. Change the Pressure Limit in Calibration/Setup to a higher limit (maximum Pressure Limit is 300 mmHg), Chapter 4, page 36.
Keypad does not accept input	The keypad is being continually depressed. Keypad failure	Release the keypad and the constant beep will cease. If the alarm persists, power off and service machine.
Keypad is too sensitive or not responsive	Keypad sensitivity in Setup Routine has been set at Fast or Slow.	Reset keypad sensitivity in System Setup, Chapter 4, page 36.
No message, beep tone	Power switch not completely depressed, or membrane switch failed.	Depress power switch completely. If problem persists, replace the membrane switch.
No power or battery run time is too short	Power cord not plugged into AC power. Batteries discharged in DC operation.	Change AC power source; check power cord connections. Recharge internal battery by connecting the power cord to the AC line. If the battery run time is less than ½ hour after a full 8 hour charge, call service to replace the rechargeable battery.

### Chapter 3: Alarms and Troubleshooting Guide

ALARM MESSAGE	POSSIBLE CONDITION	OPERATOR ACTION
<p>Power off immediately after switch to ON.</p> <p>System turns on for 2-3 seconds, then turn off automatically</p>	<p>IGBT's on Driver 'A' and 'B' shorted.</p> <p>EPROM is not seated in the socket properly.</p>	<p>If the problem persists, power off and service machine.</p> <p>Service machine.</p>
<p>Pump is running too loud</p>	<p>Roller pump is hitting the door or pump tubing is not properly installed.</p>	<p>Open the door and reinsert the pump tubing.</p> <p>Check to make sure that there is no blood or debris around the door hinges causing the door to lift up resulting in the roller pump hitting the door hub.</p>
<p>System does not heat to physiological temperature</p>	<p>Windows on the disposable or IR sensor is wet or dirty.</p> <p>Power module is not calibrated properly.</p> <p>Power module malfunction or temperature probes are out of calibration.</p>	<p>Examine the windows on the disposable set for wetness or contaminants.</p> <p>Clean IR sensor window with soft cloth and alcohol if necessary.</p> <p>The input temperature is too low and the flow rate is too high.</p> <p>Service machine if problem persists.</p>
<p>System does not prime</p>	<p>See Fluid Out in Alarm Message of this chapter</p>	<p>Check the reservoir or recirculate line and make certain that it is not obstructed, the fluid bags are fully spiked, and clamps are open. The pump tubing should not be stretched too taut and it must be firmly seated within the sensor.</p> <p>See Fluid Out in Alarm Message of this chapter</p>
<p>Unable to calibrate temperature probes</p>	<p>Temp probe malfunction</p> <p>Incorrect fluid temperature used for calibration.</p>	<p>Check the temperature of fluid and make certain it is correct.</p> <p>If problem persists, service machine.</p>
<p>Unable to turn the system off</p>	<p>One of the components on Daughter Board failed.</p>	<p>Service machine.</p>



## Chapter 4: Parameters Setting and Preventative Maintenance

### Introduction

The Belmont® Rapid Infuser RI-2, requires minimal service and care. Preventive maintenance should be performed regularly to optimize performance and reduce the likelihood of downtime. Listed below are routine maintenance (as needed), periodic maintenance (at least once a year), and parameters setting. The instrument does not need regular calibration.

#### **WARNING!**

Practice standard precautions when handling blood products. Treat all blood as if it were infected and clean up all spills immediately.

#### **WARNING!**

Do not access hardware verification while the instrument is connected to patient.

#### **CAUTION:**

Turn the system to OFF and unplug the power cord before cleaning to avoid electric shock.

#### **CAUTION:**

Immediately wipe any spills from device.

## Chapter 4: Parameters Setting and Preventative Maintenance

### System Setup

Changes in system setup can be made to:

1. Date and time
2. Display brightness
3. Language Setup
4. Key Rate
5. Bolus delivery volume
6. Pressure limits for High Pressure Alarm

Parameter Setup changes is performed in the Service mode.

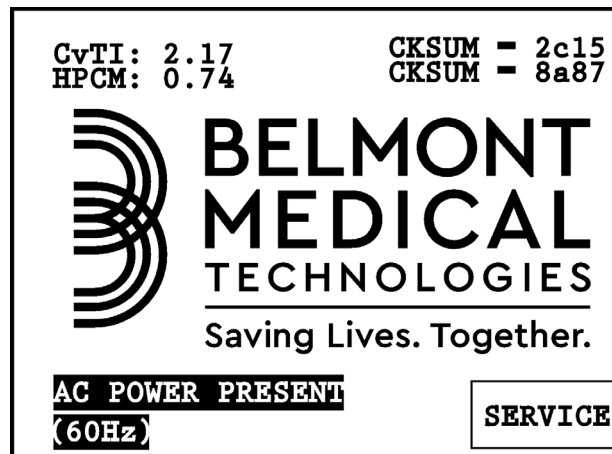

Pressing the SERVICE key accesses the SERVICE mode. This key appears on the BELMONT logo screen only at system powered-up. This screen remains active for 4.5 seconds before the system enters the PRIME mode.

CALIBRATION/SET-UP			
TIME	14:43	DATE	08-26-22
BOLUS	100ml	PRESS LIMIT	300mmHg
AC POWER PRESENT (60HZ)			
PUMP	239	HOURS INFUSE	840 L
	DATE TIME	DISPLAY BRIGHT	LANG. SETUP
TEMP CAL	PRESS CAL	POWER CAL	FAST KEYSRATE
PRESS LIMIT	HARDWARE	SETUP BOLUS	EXIT SERVICE



## Chapter 4: Parameters Setting and Preventative Maintenance

### 2. Display Brightness

There are four (4) levels of display brightness. Press DISPLAY BRIGHT to change the present level of brightness to the next level.

### 3. Language Setup

Press this key to set screens to your preferred language.

### 4. Key Rate

The key rate sets up the sensitivity of the touch keys. There are three different levels of sensitivity; FAST, MEDIUM and SLOW. The current level of sensitivity is indicated on the key itself. The FAST setting requires the least amount of time for a key to respond. The MEDIUM setting requires more time and the SLOW key requires the most time and makes the touch keys least sensitive. **The key sensitivity is set at factory to Fast.**

Note that this key changes the time required to depress a key for stroke to be recognized. The pressure required is not affected.

### 5. Bolus Volume

The bolus volume can be set from 100 to 1000 ml and can be changed from 100, 200,400, 500, and 1000 ml each time SETUP BOLUS key is pressed. The current bolus volume is indicated at the BOLUS status line in the Calibration/Setup screen. The bolus volume is also displayed within the BOLUS key in the Infuse screen (see Chapter 2 under Main Infuse screen).

### 6. Pressure Limit

The user can set the maximum allowable in-line pressure. The possible setting ranges from 100 to 300 mmHg. The current pressure limit value is displayed on the PRESS LIMIT status line on the Calibration/Set-Up screen. Press and hold the key to change the limit in increments of 50 mmHg. During infusion, the system keeps the pressure in the line under the pressure limit by reducing the infusion rate as the in-line pressure approaches the pressure limit. **The pressure limit is automatically reset to 300 mmHg each time that the system is powered on.**

## Chapter 4: Parameters Setting and Preventative Maintenance

### Service and Preventive Maintenance Schedule

#### Schedule 1

To be performed by either the Clinical User or a Biomedical Technician (BMET).

Routine Maintenance	Interval	
	Before or After Each Use	Every Month
1. Clean and/or Disinfect Exterior, if necessary.	•	
2. Clean Fluid Out and In-Line Air Detector.	•	
3. Check the Power Cord.	•	
4. Clean Temperature Probes	•	
5. Check/Clean the Fan Guard.		•

#### Schedule 2

To be performed by either a BMET or other qualified service personnel.

Required Test/Verification	Interval	
	Every 6 Months	Every Year
1. Perform Visual Inspection.	•	
2. Perform System Operational Check-Out, including the Audible Alarm Test.	•	
3. Check the System Seal.	•	
4. Check Instrument Door and Ceramic Disk.	•	
5. Check Rubber Feet.	•	
6. Check the battery for rated voltage and check battery run time. Replace batteries when operating time is marginal or after 3 years.	•	
7. Perform Electrical Safety Test.		•
8. Hardware Verification.		•
9. Clean Pump Head		•

**Routine Maintenance**

**1. Clean Device Exterior**

Thoroughly clean the outside surfaces of the system and inside the door after each use. Inspect all surfaces of the device for soil immediately following the procedure and, if soil is present, follow the procedures outlines in this section.

**Note:** Avoid the use of acetone or other solvents that might damage the surface. Do not spray cleaning liquids into or onto the air vents at the bottom of the system. Do not use any cleaners that contain quaternary ammonium compounds, these ingredients may degrade the plastics used in the machine.

- a. Turn the pump to OFF and unplug the power cord from the wall.
- b. Ensure the disposable is removed and discarded according to hospital procedures.
- c. Use CaviWipes™ or equivalent per the manufacturer's instructions to wipe all surfaces until thoroughly wet to remove organic residue.
  - i. Open the door fully and pull straight up to remove the door from the device to make some hard-to-reach surfaces easier to clean.

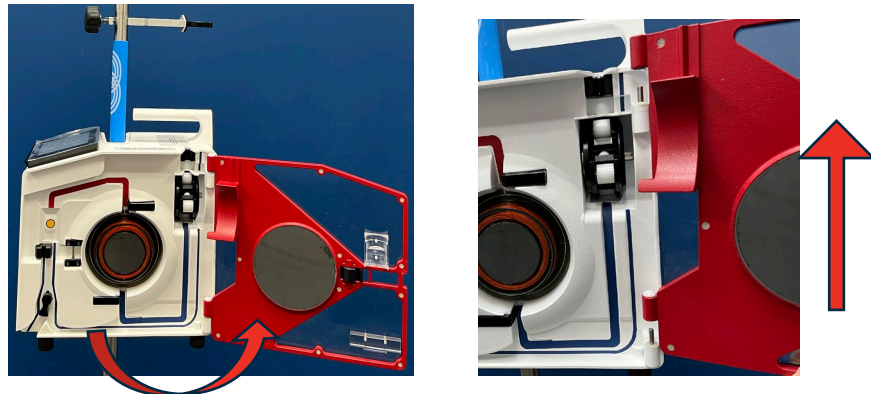

- d. Thorough cleaning is essential, ensure the following areas are cleaned:
  - i. Touchscreen
  - ii. Handle
  - iii. Moisture Guard and Power Cord



## Chapter 4: Parameters Setting and Preventative Maintenance

- iv. Power Switch
- v. Power Entry Module
- vi. Door Hinges

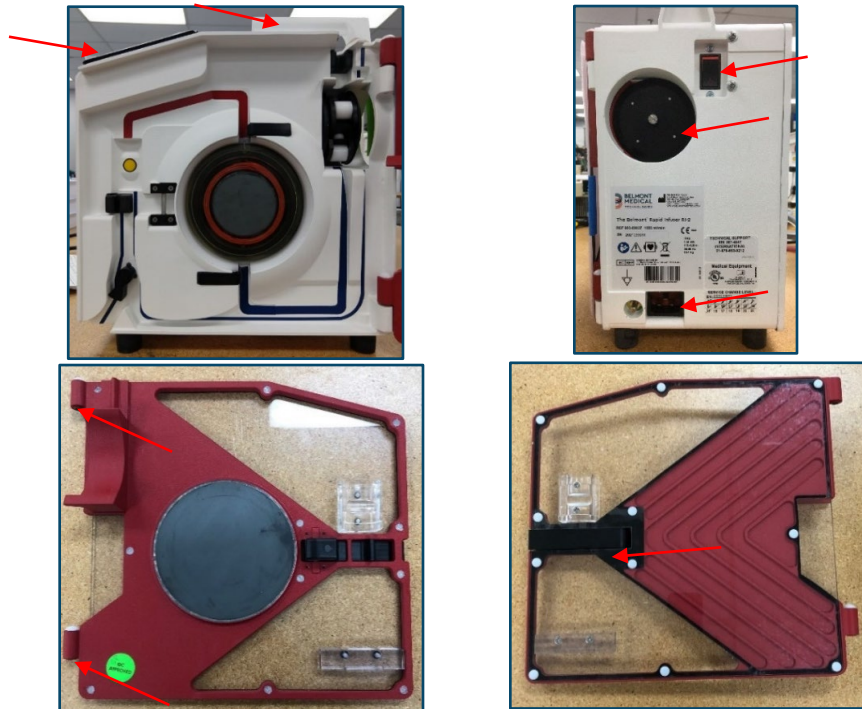

- e. Fluid-Out and In-Line Air Detectors
  - i. Keep the fluid-out and air detectors clean and dry. If they become dirty or wet, clean with a moistened cotton swab and dry. Air detector surfaces are delicate. Use care when carrying out this procedure.
- f. Temperature Probes
  - i. Keep the probe sensors clean and dry. If they become dirty or wet, clean with a moistened cotton swab and dry. Use care not to damage the sensor surface.



- g. Fan Guards
  - i. Inspect the fan guards on the bottom of the unit for debris that might impede air flow. Remove guards by unscrewing the 4 retaining screws and clean, if necessary. Make certain the guards are not damaged. Let the fan guards dry before reinstalling.

## Chapter 4: Parameters Setting and Preventative Maintenance

### h. Pump Head

- i. If needed, remove the pump head for cleaning to remove any organic residue.
  1. Unscrew the retaining screw that holds the pump head.

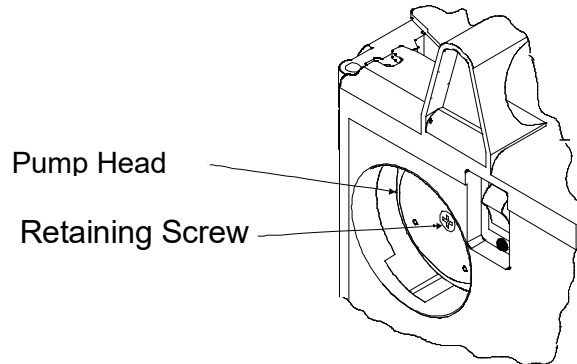

2. Remove the pump head and clean with water and soap.
3. Let the pump head dry before replacing.
4. Replace the pump head and ensure the retaining screw is securely fastened.
5. If the pump head squeaks, spray the roller with silicone spray.

### i. Visual Inspection

- ii. Check entire device for residual dried organic residue.
- iii. Use CaviWipes™ or equivalent to remove any missed organic residue. Repeat until all organic residue has been removed prior to disinfecting the device per the section below.

## Disinfect Device Exterior

After removal of all visible soil, allow at least 3 minutes for the device surfaces to dry before proceeding with the disinfection procedure below. Disinfect the outside surfaces of the system and inside the door after each use.

**Note:** Avoid the use of acetone or other solvents that might damage the surface. Do not spray cleaning liquids into or onto the air vents at the bottom of the system. Do not use any cleaners that contain quaternary ammonium compounds, these ingredients may degrade the plastics used in the machine.

- a. Turn the pump to OFF and unplug the power cord from the wall.
- b. Ensure the disposable is removed and discarded according to hospital procedures.
- c. Use CaviWipes™ or equivalent per the manufacturer's instructions to wipe all surfaces until thoroughly wet. Continually wipe each surface to keep wet for at least 6 minutes.
  - i. Disinfect all surfaces reviewed in the cleaning section above.
- d. Let device air dry completely.



## Chapter 4: Parameters Setting and Preventative Maintenance

- e. Fluid-Out and In-Line Air Detectors
  - iv. Keep the fluid-out and air detectors clean and dry. If they become dirty or wet, clean with a moistened cotton swab and dry. Air detector surfaces are delicate. Use care when carrying out this procedure.
- f. Temperature Probes
  - v. Keep the probe sensors clean and dry. If they become dirty or wet, clean with a moistened cotton swab and dry. Use care not to damage the sensor surface.

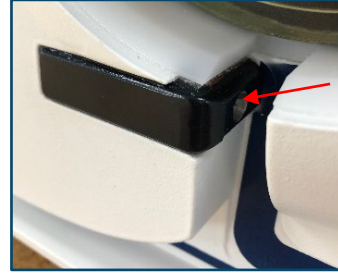
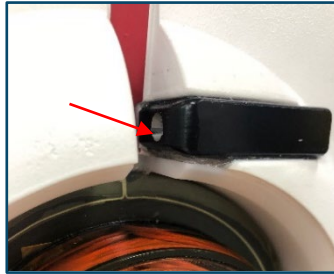

### 2. Power Cord

Inspect the power cord along its length and connectors for cuts and breaks. Ensure moisture guard is present. Replace power cord or moisture guard if damaged.

## Chapter 4: Parameters Setting and Preventative Maintenance

### Testing the System and Operational Check-Out

The device should be serviced periodically, in accordance to schedule 1 and 2, by a qualified technician.

#### Material Required:

- Rapid Infuser Disposable Set, REF 903-00006
- Bio-Tek Safety Analyzer or equivalent
- Saline or other crystalloid for testing
- 2 liters of 35° - 42°C fluid
- Manometer (2 mmHg resolution)
- Pressure source
- Thermometer with thermocouple (0.1°C resolution)
- Graduated cylinders (ASTM Class B accuracy)
- Timer

#### 1. Visual Inspection

- a. Door Open/Right Hand Side:
  - a. Check that air and fluid out detectors are clean.
  - b. Check that all the plastic push pins on the door are in-place.
  - c. Check that the valve pincher set screw is tight.
  - d. Check that there are no cracks in the ferrite on either the door or the right-hand side.
  - e. Check that the pressure transducer diaphragm has no tears or rips.
  - f. Check that each pump roller spins freely. If not, remove and clean.
  - g. Check that the door is pushed all the way down and there is no dried blood or fluid inside or around the hinges.
- b. Back:
  - i. Check that the AC connector (IEC connector) is clean. If there is some saline residue, clean.
  - j. Check that the moisture guard is installed and undamaged. Call Belmont Technical Support to request a replacement if needed.
- c. Verify Latch/Unlatch Mechanism:
  - i. Check the rubber pads on the pole clamp assembly. If they feel slick/polished, clean and scrub with isopropyl alcohol.
  - ii. Mount and un-mount the system on an IV pole, verify that the latch and unlatch work properly and the system will not move down the pole unexpectedly.

## Chapter 4: Parameters Setting and Preventative Maintenance

### 2. Seals

Inspect the seal around the unit to make certain it is in good condition. Check also the seal around the touch screen and ceramic disks. Use Dow Corning 732 multipurpose RTV sealant or equivalent if needed to maintain fluid resistance.

### 3. Instrument Door and Ceramic Disks

The instrument door must fit properly for the system to operate correctly. The platen part of the roller pump is located on the door. The platen must line up properly with the pump.

- a. Check hinges for blood build-up, clean any dried blood from hinge area. Be sure that door is seated completely down on the hinges.
- b. Check plastic rivets and door integrity. Make sure that the door frame is not bent. Replace, if bent.
- c. Inspect the ceramic disks on the door and in the center of the unit for cracks. Return to manufacturer for replacement if they are damaged.

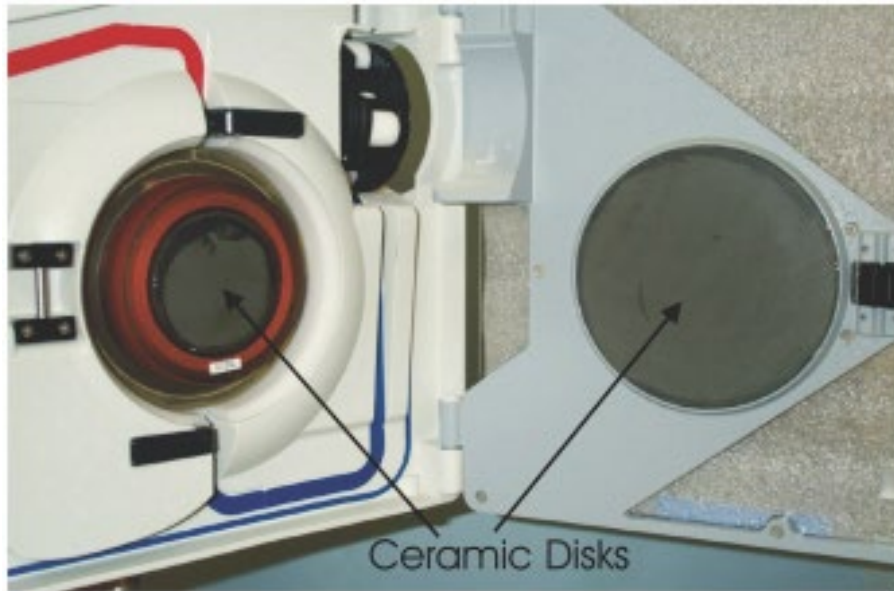

### 4. Rubber Feet

Inspect the rubber feet on the bottom of the unit for cracked or missing rubber feet. Replace if necessary.

## Chapter 4: Parameters Setting and Preventative Maintenance

### 5. System Operational Check-Out

- a. Install Disposable set.
- b. Turn power switch ON. Wait for PRIME screen to appear.
- c. Close bag clamps. Hang and spike fluid bag.
- d. Open bag clamp(s). Press PRIME to prime the system (circulate 100 ml of fluid at 500 ml/min.) Prime volume (100 ml) countdown is displayed on screen. Stop automatically when countdown reaches 0 ml.
- e. Press PT. LINE PRIME once to pump at 50 ml/min or press and hold to pump at 200 ml/min. Press STOP when line is free of air bubbles.
- f. Press INFUSE to start infusion at 10 ml/min. Press INFUSE RATE ▲ ▼ to change flow rate.
- g. Increase flow rate to 500 ml/min and verify that the output temperature, on the display, is  $37.5^{\circ} \pm 1^{\circ}\text{C}$ .
- h. Unplug power cord from AC outlet. Verify that the system automatically switches to battery when AC is disconnected. BATTERY NO HEATING message displays to indicate the system is now in battery mode and heating is suspended.
- i. Connect back to AC power and verify the operation is uninterrupted. Adjust the flow rate by pressing INFUSE RATE ▲ ▼.
- j. Infuse until the fluid bag is empty, verify that the system stops pumping and sounds an audible alarm with 'FLUID OUT' message displays on screen.

### 6. Battery Run Time

- a. Prior to performing the battery run test, plug the system into an AC wall outlet for at least 8 hours to fully charge the batteries.
- b. Follow directions in Step 2, a-g. Infuse at 50 ml/min. Start the timer.
- c. The system should run for at least 30 minutes with fully charged battery. If not, replace the batteries.

## Chapter 4: Parameters Setting and Preventative Maintenance

### 7. Electrical Safety Test - Leakage Current

**Equipment required:** Fluke Safety Analyzer, Model 505 or equivalent  
2 Liters of room temperature saline

**Setup:** Plug the Belmont® Rapid Infuser RI-2 into AC outlet on the panel of the Safety Analyzer.

#### **CAUTION:**

Before applying voltage to Safety Analyzer, make sure input line voltage is correct for the **VOLTAGE OF UNIT UNDER TEST.**

#### **a. Earth Leakage Currents:**

- i. Plug the Safety Analyzer into an appropriate power source, turn Analyzer power ON. Turn the Belmont® Rapid Infuser RI-2 power switch to OFF.
- ii. Switch selector on Analyzer to CHASSIS or LEAKAGE ( $\mu\text{A}$ ). Connect a single red lead to the SINGLE LEAD input jack and attach large clamp to equipotential ground terminal on the Belmont® Rapid Infuser RI-2.
- iii. Record the leakage current displayed for each of the following conditions, with Neutral switch in NORM position. Tests should be performed in the following order.
  - Polarity - NORM; Ground – NORM
  - Polarity - REVERSE; Ground – NORM
  - Polarity - REVERSE; Ground – OPEN
  - Polarity - NORM; Ground - OPEN
- iv. Repeat the first two (Normal Polarity and Reverse Polarity - Grounded) with Neutral switch in OPEN position
- v. Install the disposable set and prime with saline and proceed to the Infuse screen. Press STOP to set the pump at 0 ml/min, not heating or pumping.
- vi. Repeat iii & iv with the Belmont® Rapid Infuser RI-2 in ON mode (power switch ON, infuse screen displayed, not pumping or heating).
- vii. Repeat iii & iv with the Belmont® Rapid Infuser RI-2 infusing and heating at maximum rate.
- viii. All measurements should be  $<300 \mu\text{A}$  (for Domestic unit) and  $<500 \mu\text{A}$  (for 230 V unit).

## Chapter 4: Parameters Setting and Preventative Maintenance

### b. Patient Leakage Current:

- i. Install the disposable set and prime with saline and proceed to the Infuse screen.
- ii. Attach 12 to 16-gauge stainless steel cannula or hypodermic needle tip to the end of patient line and attach the Safety Analyzer large clamp to the cannula or needle tip.
- iii. Prime the Belmont® Rapid Infuser RI-2 with saline. Make sure that the entire patient line including the cannula has been primed.
- iv. Repeat a.iii, and a.iv with the Belmont® Rapid Infuser RI-2 in the STANDBY (ON) and pumping at 750 ml/min modes.
- v. Maximum leakage allowable is as follows:

#### **With NORMAL NEUTRAL**

Normal Polarity - Grounded (10  $\mu$ A)

Reverse Polarity - Grounded (10  $\mu$ A)

Reverse Polarity - Not Grounded (50  $\mu$ A)

Normal Polarity - Not Grounded (50  $\mu$ A)

**With OPEN NEUTRAL** (Note: the system automatically switches to battery at 50 ml/min.)

Normal Polarity - Grounded (50  $\mu$ A)

Reverse Polarity - Grounded (50  $\mu$ A)

### 8. Hardware Verification

Install and prime the disposable set before beginning the Hardware Verification process.

#### **Hardware mode verifies:**

- a. Valve operation
- b. Fluid Out and Air Detectors
- c. Battery voltage
- d. Flow Rate (Pump speed)
- e. Input and Output Temperature Probes including "Over Temperature" alarm test
- f. Pressure sensor

A password is required to access the SERVICE screen, to ensure that this mode is not accessed accidentally.

Press the SERVICE key, at power-up, to access the Calibration/Set-up screen. This screen remains active for 4.5 seconds before the system enters the Prime mode screen.

- Press HARDWARE from the Calibration/Set-Up screen.
- Enter the Password 013192.

## Chapter 4: Parameters Setting and Preventative Maintenance

<b>CALIBRATION/SET-UP</b>			
TIME	14:43	DATE	08-26-22
BOLUS	100ml	PRESS LIMIT	300mmHg
AC POWER	PRESENT (60HZ)		
PUMP	239	HOURS INFUSE	840 L
	DATE TIME	DISPLAY BRIGHT	LANG. SETUP
TEMP CAL	PRESS CAL	POWER CAL	FAST KEYPATE
PRESS LIMIT	HARD-WARE	SETUP BOLUS	EXIT SERVICE

Calibration/Setup Screen

PUMP SPEED	0	ml/min	
INPUT TEMPERATURE	23.0	(23.0)	
OUTPUT TEMPERATURE	23.0	(23.0)	
PRESSURE	0	mmHg	
FLUID OUT DETECTOR STATUS	AIR		
AIR DETECTOR STATUS	AIR		
BATTERY VOLTAGE	28.5		
BOARD TEMPERATURE	23	C	
		PUMP SPEED	
LEFT VALVE	OPEN VALVE	RIGHT VALVE	CANCEL

Hardware Status Screen

Status Line	Reading
Pump Speed	0, 10, 100, 500, 750, and an optional 1000 ml/min
Input Temperature	Temperature in °C, probe ambient reference in parentheses
Output Temperature	Temperature in °C, probe ambient reference in parentheses
Pressure	Pressure in mmHg
Fluid Out Detector Status	Air or Fluid
Air Detector Status	Air or Fluid
Battery Voltage	Battery charge level in volts
Board Temperature	Temperature of the circuit board inside the case.

## Chapter 4: Parameters Setting and Preventative Maintenance

Function Key	Action
PUMP SPEED	Change pump speed.
LEFT VALVE	Move the valve to the left or recirculate position.
OPEN VALVE	Move the valve to the middle or load position.
RIGHT VALVE	Move the valve to the right or infuse position.
CANCEL	Exit Hardware status and return to the Calibration/Set-Up screen.

### Hardware Verification:

#### a. Valve

- i. Press LEFT VALVE, confirm that the valve wand (valve pincher) moves to the left.
- ii. Press OPEN VALVE, confirm that valve wand moves to the middle position.
- iii. Press RIGHT VALVE, confirm that the valve wand moves to the right. Leave the valve in the LEFT VALVE position before continuing to the next step.

#### b. Fluid Out and Air Detectors

- i. Confirm that the Fluid Out Detector and the Air Detector status lines display FLUID when the system is primed, and no air is in the detectors.
- ii. Open the door and pull out the tubing from the detectors. Close the door and confirm that the status line display AIR when the tubing is removed from the sensor.

#### c. Battery Voltage

Unplug the unit from the wall outlet. 'Battery voltage' displayed in HARDWARE screen, should be approximately 24 volts. If not, recharge the battery for at least 8 hours and recheck. Plug the unit back into the wall outlet.

#### d. Flow Rate

The flow rate can be verified by measuring the flow using a graduated cylinder and timer. Choose the method that best serves your setup.

### Directly measure the flow:

- i. Make certain the patient line and entire disposable is fully primed before measuring. Set the pump speed to 10 ml/min. Press RIGHT VALVE to set the valve into the infuse position and fill the patient line. Use a graduated cylinder to measure flow at the patient line for ten minutes and verify the average flow rate over that period. The volume collected should be  $100 \pm 25$  ml for an averaged flow rate of  $10 \pm 2.5$  ml/min.
- ii. Press PUMP SPEED again to change the pump speed to 100 ml/min and measure the flow with a graduated cylinder for one minute. The accepted tolerance is  $100 \pm 10$  ml/min.
- iii. Press once more to change speed to 500 ml/min and repeat the measurement. The accepted tolerance is  $500 \pm 50$  ml/min.
- iv. Press once more to change speed to 750 ml/min and repeat the measurement.



## Chapter 4: Parameters Setting and Preventative Maintenance

The accepted tolerance is  $750 \pm 75$  ml/min.

- v. For 1000 ml/min option, press once more to change speed to 1000 ml/min and repeat the measurement. The accepted tolerance is  $1000 \pm 100$  ml/min.

### e. Input and Output Temperature Probes and “Over Temperature” Alarm

Prepare at least 2 liters of  $37^{\circ}$  -  $43^{\circ}\text{C}$  fluid

- i. Connect the fluid supply to the disposable. Remove the patient line from the luer connector. Insert the thermocouple approximately 2” into the connector previously connected to the patient line.
- ii. Press the RIGHT VALVE key to set the valve to the infuse position. Open the fluid supply and set the pump speed to 500 ml/min.
- iii. Let the temperature stabilize, wait at least 2 minutes. The INPUT TEMPERATURE and OUTPUT TEMPERATURE value readings (the values not between the parentheses) should be within ( $2^{\circ}\text{C}$ ).
- iv. Compare the numbers displayed, on screen, to the thermocouple reading. The accepted tolerance is  $1^{\circ}\text{C}$  for fluid temperature between  $30^{\circ}\text{C}$  to  $40^{\circ}\text{C}$  and  $2^{\circ}\text{C}$  outside this range.
- v. Press PUMP SPEED to set the pump speed back to 0 ml/min.
- vi. Press CANCEL to return to the Calibration/Set-Up screen.
- vii. Press EXIT SERVICE to return to PRIME screen.
- viii. Prime the unit and the patient line with room temperature water.
- ix. Prepare at least 2 liters of  $43^{\circ}$  –  $45^{\circ}\text{C}$  fluid.
- x. Connect this fluid supply to the disposable. Infuse at 500 ml/min.
- xi. Compare the numbers displayed, on screen, to the thermocouple reading. The alarm sounds when the screen reads between  $42^{\circ}$  –  $42.5^{\circ}\text{C}$ .
- xii. Record the temperature when the “Over Temperature” alarm occurs. The accepted tolerance of the temperature between the thermocouple and on the screen should be within  $1^{\circ}\text{C}$  to  $2^{\circ}\text{C}$  of each other.

## Chapter 4: Parameters Setting and Preventative Maintenance

### f. Pressure Transducer

#### **WARNING!**

Do not apply excessive pressure to the pressure chamber or pressure transducer. The pressure transducer is a precision electromechanical device and can be damaged with excessive force. **Do not use the system if the pressure transducer is damaged.**

- i. **Inspect the pressure transducer for damage. Make certain the surface of the transducer is not cut or punctured. The pressure transducer must be replaced if the surface is damaged.**
- ii. Make certain the pressure chamber is properly installed (see Chapter 2: Installing the Disposable) and the flow path is not blocked.
- iii. Make certain the fluid is warm (37° – 42°C). The pressure chamber of the disposable is less compliant when it is at room temperature. **Verification must be performed with a warm disposable.** If the fluid is not warm, go to the Main Infuse screen and warm the fluid and disposable by pressing the RECIRC key (Chapter 2: Main Operating Screen: Recirculating Mode). Let the fluid recirculated for at least two minutes in AC power before returning to the Hardware mode for verification.
- iv. In the Hardware mode: close the door, the bag clamps and block the air vent on top of the reservoir chamber. Disconnect the patient line and connect the pressure source to the luer fitting at the patient line port of the disposable set and apply pressure while monitoring the amount of pressure with a manometer.
- v. Verify the accuracy of the pressure transducer. Apply 300 mmHg into the disposable. The pressure status line should read 300 mmHg (± 50 mmHg). Repeat the same pressure verification for 200 and 100 mmHg.

## Chapter 4: Parameters Setting and Preventative Maintenance

### 9. Clean the Pump Head

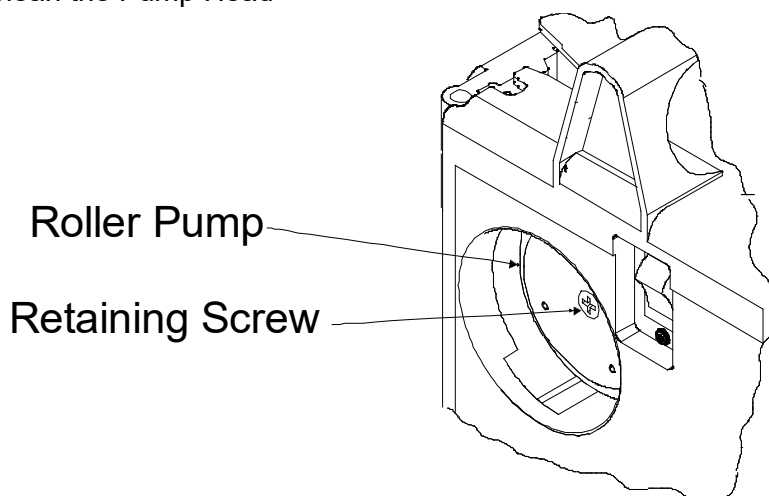

The pump head can be removed and cleaned if needed.

- a. Turn the pump OFF and unplug the power cord from the wall.
- b. Unscrew the retaining screw that holds the pump head.
- c. Remove the pump head and clean with water and soap. Hydrogen peroxide or a mild bleach solution can be used to disinfect.
- d. Let pump head dry before replacing and make certain the pump head is securely fastened with the retaining screw.
- e. If the pump head squeaks, spray the roller with Silicone spray (Heavy Duty Pure Silicone.)

## Chapter 4: Parameters Setting and Preventative Maintenance

### Checklist

RI-2 S/N:	Tested By:	Date:
-----------	------------	-------

Equipment Used:	Safety Analyzer S/N:	Cal Due Date:
	Pressure Source S/N:	Cal Due Date:
	Thermometer S/N:	Cal Due Date:

	Results	
<b>1. Visual Inspection:</b>		
a. Right Hand Side		√ if OK
b. Back		
c. Latch/Unlatch		
<b>2. Operational Check Out</b>		
a. Prime		√ if OK
b. PT. LINR PRIME		
c. INFUSE ▲ ▼		
d. Output Temperature @ 500mL/min		
e. AC to DC switch over		
f. DC to AC switch		
g. FLUID OUT audible alarm		
<b>3. Battery Run Time Test</b>		> 30 min.
<b>4. Electrical Safety Check</b> (See attached Results Sheet)		√ if OK
a. Earth Leakage Current		
b. Patient Leakage Current		
<b>5. Hardware Verification:</b>		
a. Valve Operation		√ if OK
b. Fluid Out and Air Detectors		√ if OK
c. Battery Voltage		Approx. 24 V
d. Flow Rate		√ if OK
e. Input and Output Temperature Probes		√ if OK
Temp. when "Over Temp" alarm: On screen Thermocouple		42° to 42.5°C 1° to 2°C of screen
f. Pressure Sensor		√ if OK
<b>6. Clean Pump Head</b>		√ if done

## Chapter 4: Parameters Setting and Preventative Maintenance

### Electrical Safety Test - Leakage Current Results Sheet

a. **Earth Leakage Currents** (all measurements are in  $\mu\text{A}$ )

	Polarity - N; Ground - N	Polarity - R; Ground - N	Polarity - R; Ground - O	Polarity - N; Ground - O
<b>Unit in OFF</b>				
• Neutral – NORM				
• Neutral – OPEN				
<b>Unit in ON, not pumping</b>				
▪ Neutral – NORM				
▪ Neutral – OPEN				
<b>Unit in ON, infusing @ 750 ml/min.</b>				
• Neutral – NORM				
• Neutral - OPEN				

b. **Patient Leakage Currents** (all measurements are in  $\mu\text{A}$ )

	Polarity - N; Ground - N	Polarity - R; Ground - N	Polarity - R; Ground - O	Polarity - N; Ground - O
<b>Unit in OFF</b>				
• Neutral – NORM				
• Neutral – OPEN				
<b>Unit in ON, not pumping</b>				
• Neutral – NORM				
• Neutral – OPEN				
<b>Unit in ON, infusing @ 750 ml/min.</b>				
▪ Neutral – NORM				
▪ Neutral - OPEN				

## Chapter 4: Parameters Setting and Preventative Maintenance

### Fuse

The fuse on the AC/DC supply marked F1 is rated as 1.25A, 250V, fast acting, 5x20mm with interrupting rating (breaking capacity) of 35A@250VAC.

### Calling for Service

USA: 855.397.4547

Worldwide: +1.978.663.0212

Prior to returning any product, please obtain a Return Materials Authorization (RMA) number.

Before calling, please have the serial number of the unit. The serial number is located on the label above the power receptacle.

### Electromagnetic Compatibility

#### WARNING!

Medical Electrical Equipment needs special precautions regarding EMC and needs to be installed and put into service according to the Electromagnetic Compatibility [EMC] information provided in the accompanying documents.

#### WARNING!

Portable and Mobile RF Communications Equipment can affect Medical Electrical Equipment.

**NOTE:** The EMC tables and other guidelines that are included in the Operators Manual provide information to the customer or user that is essential in determining the suitability of the Equipment or System for the Electromagnetic Environment of use, and in managing the Electromagnetic Environment of use to permit the Equipment or System to perform its intended use without disturbing other Equipment and Systems or non-medical electrical equipment.

The essential performance features of The Belmont Rapid Infuser RI-2 are the accuracy of the flow rate, the accuracy of the maximum heating condition and the air detector functionality. If any of these systems performance is degraded or lost due to electromagnetic disturbances the system will alarm to alert the user.

Table 201

#### Guidance and Manufacturer's Declaration – Emissions All Equipment and Systems

The **Belmont® Rapid Infuser RI-2** is intended for use in the electromagnetic environment specified below. The customer or user of the **Belmont® Rapid Infuser RI-2** should assure that it is used in such an environment.

Emissions Test	Compliance	Electromagnetic Enforcement – guidance
RF Emissions CISPR 11	Group 1, Class A	The <b>Belmont® Rapid Infuser RI-2</b> uses RF energy only for its internal function. Therefore, its RF emissions are very low and are not likely to cause any interference in nearby electronic equipment.
Harmonics IEC 61000-3-2	Complies or Not applicable	Not Applicable
Flicker IEC 61000-3-3	Complies or Not applicable	Not Applicable

## Chapter 4: Parameters Setting and Preventative Maintenance

**Table 202**

**Guidance and Manufacturer's Declaration—Immunity All Equipment and Systems**

The **Belmont® Rapid Infuser RI-2** is intended for use in the electromagnetic environment specified below. The customer or user of the **Belmont® Rapid Infuser RI-2** should assure that it is used in such an environment.

Immunity Test	IEC 60601 Passed Parameters
IEC 61000-4-2 Electrostatic Discharge (ESD)	±8kV contact ±15kV air
IEC 61000-4-3 Radiated RF	3 V/m 80MHz-2.7GHz 80% AM @ 1kHz
IEC 61000-4-3 Proximity field Immunity	385 MHz at 27 V/m, 18 Hz Pulse Modulation 450 MHz at 28 V/m, 1 kHz Frequency Modulation ± 5 kHz Dev 810 MHz, 870 MHz, 930 MHz at 28 V/m, 18 Hz Pulse Modulation 710 MHz, 745 MHz, 780 MHz at 9 V/m, 217 Hz Pulse Modulation 1720 MHz, 1845 MHz, 1970 MHz, 2450 MHz at 28 V/m, 217 Hz Pulse Modulation 5240 MHz, 5500 MHz, 5785 MHz at 9 V/m, 217 Hz Pulse Modulation
IEC 61000-4-4 Electrical Fast Transient/burst	±2kV on AC Mains 100kHz Repetition frequency
IEC 61000-4-5 Surge	±1kV Line-to-line ±2kV Line-to-earth
IEC 61000-4-6 Conducted RF	3 Vrms from 150 kHz to 80 MHz 6Vrms in ISM bands between 0.15 MHz and 80 MHz 80% AM @1kHz
IEC 61000-4-8 Power Frequency 50/60Hz Magnetic Field	30A/m
IEC 61000-4-11 Voltage dips, short interruptions and voltage variations on power supply input lines	100% Dip for 0.5 Cycle @ 0°, 45°, 90°, 135°, 180°, 225°, 270°, and 315° 100% Dip for 1 Cycle 30% Dip for 25 Cycles 100% Dip for 5 Seconds

**Technical Specifications of the Belmont® Rapid Infuser RI-2**

<b>Dimensions</b>	
Size	12.4" x 7.5" x 14.8" (315 mm x 191 mm x 376 mm)
Weight	28 lbs (12.7 Kg)

<b>Portability</b>	
Hand Carry	Handle on top of unit for easy transport
IV Pole Mount	IV pole mountable or free standing. I.V pole diameter range of pole mount: 1" - 1 1/4"

<b>Power AC</b>	
AC Input Voltage	115-120 V ~ 20 amp dedicated or 230 V ~ 10 amp dedicated
Fuse	1.25A, 250V, Fast Acting, 5x20mm with interrupting rating (breaking capacity) of 35A@250VAC
Operating Frequency	50/60 Hz
Maximum Power	1440 VA
Line Isolation	1500 V to ground
Earth Leakage Current	< 300 µA (For Domestic unit) < 500 µA (For 230 V ~ unit)
Electrical Compliance	EN 60601-1, CSA/C22.2 - No. 601.1-M90
Circuit Breaker	15Amp, 125VAC/250VAC, 50/60 Hz
Power Cord	U.S.: 3 conductors, 14 AWG type SJT Cord with Hospital grade plug and moisture guard
	Outside U.S.: 3 x 1.5 mm <sup>2</sup> International Harmonized Cordage with Hospital grade plug and moisture guard



## Chapter 5: Technical Specification of The Belmont® Rapid Infuser RI-2

<b>Battery</b>	
Type	Rechargeable lead acid
Running Time	> 30 minutes at 50 ml/min. without heat
Recharge Time	8 hours

<b>Environment</b>	
Operating Temperature	10°C to 32°C (50°F to 90°F)
Storage Temperature	-15°C to 40°C (5°F-104°F)
Relative Humidity	10% to 90%
Pressure	49-103 kPa

<b>Operating Parameters</b>	
Flow Rate	10 - 750 ml/min, with a 1000 ml/min as an option, in 10 ml/min steps plus 2.5 and 5.0 ml/min with fluids of viscosity 1 to 8 centipoise (Water and crystalloid fluids through packed red cells)  Tolerance:     ± 10% from 20 - 1000 ml/min ± 25% for 2.5, 5.0, 10 ml/min
Output Temperature	Set to 37.5°C for flow ≥ 60 ml/min, to 39°C at 50 ml/min or lower. Tolerance: 1°C for fluid temperature between 30°C to 40°C and 2°C outside this range
Heating Capacity	Min. 1400 watts to fluid (20°C temperature rise at 1000 ml/min)
Line Pressure	0 - 300 mmHg, via pressure transducer
Operating Modes	a) Load disposable set b) Prime system c) Prime patient line d) Infuse at operator controlled rate with warming e) Infuse fixed volume bolus with warming f) Stop system
Default Settings	Flow Rate: 10mL/min Pressure: 300mmHg Bolus display: 200mL Screen Brightness: Highest Key Rate: Fast

## Chapter 5: Technical Specification of The Belmont® Rapid Infuser RI-2





<b>Operating Panel</b>	
Control Panel and Display	Splash proof touch screen display
Display Area	Diagonal screen 5.7" (14.5 cm)
Status Display	Flow rate (ml/min) Total volume infused (ml) Line pressure (mmHg) Output infusate temperature (°C) Bolus volume (ml) Alarm messages
Functional Keys	Keys are displayed appropriate to the particular point in operation
Character Display	Graphical Alarm Messages - display where errors have occurred

<b>Safety and Monitoring</b>	
Infusate Temperature	Via infrared sensors at the input and output to the heat exchanger.
Line Pressure	A pressure transducer monitors the in line pressure. If the pressure reaches the threshold set by the user, the pump will slow down until pressure falls below the threshold. If the in-line pressure rises faster than 40 mmHg/ml or exceeds 400 mmHg, an alarm sounds, the "HIGH PRESSURE" message is displayed, the line to the patient is closed and pump comes to an immediate stop.
Air Detection	Two ultrasonic air detectors monitor air in the fluid path. The fluid detector is mounted closest the fluid bag. It sounds an alarm if there is no fluid entering the system. The other air detector checks for air in the fluid line before it enters the patient line.
Valve Wand	Provides flow path to patient, or recirculation fluid path within the system. The recirculation path is used to prime the system and eliminate air after an air detection alarm. The recirculation path is activated at all alarm conditions.
<b>Product Lifetime</b>	
Product Lifetime	7 years







## Chapter 5: Technical Specification of The Belmont® Rapid Infuser RI-2

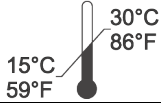

<b>Alarm States and Controls</b>	<b>ALARM MESSAGES</b>
Information Signal	LOW BATTERY
Operator Setting, User-correctable	MISSING DISPOSABLE DOOR OPEN FLUID OUT AIR DETECTION HIGH PRESSURE
Heating Alarms	SYSTEM ERROR #101 & 102
Hardware Alarms	SYSTEM ERROR #201, 202, 203, 204, 205, 206, 207, 208, 209 & 210
Audible Alarm Sound Pressure	61.6 dB at 1 m (45.1 dB ambient), high-priority per IEC 60601-1-8
Visual Alarms	Information Displayed on UI Status light above the UI

<b>Disposable Sets</b>	
3 Spike Disposable Set REF: 903-00006	Filter Size: 250 micron
3.0 Liter Reservoir REF: 903-00018	Filter Size: 160 micron













<b>Disposable Environment</b>	
Storage Temperature	15°C to 30°C (59°F-86°F)
Relative Humidity	15% to 70%
<b>Disposable Symbols and Definitions</b>	
<b>Symbol</b>	<b>Description</b>
	DO NOT USE if package has been damaged or opened
	Sterilized Using Ethylene Oxide
	Do not re-use/ Single use/ Use only once
	Compliance to Medical Device Directive 93/42/EEC and 2011/65/EU

## Chapter 5: Technical Specification of The Belmont® Rapid Infuser RI-2



	Caution
	Temperature Storage Range
	Humidity Storage Range
	Batch Code
	Use-By date
	Manufactured By
	Authorized European Representative

<b>Classifications</b>	
Type of Protection Against Electric Shock	Class I, or internally powered
Degree of Protection Against Electric Shock for applied part	CF defibrillator-proof at the end of patient line
Degree of Protection Against Harmful Ingress of Water	IPX2
Method of Sterilization	Ethylene Oxide. Disposable delivered sterile, with pyrogen-free flow path, for single use only
Degree of Safety in Presence of Flammable Anesthetics	Not suitable
Mode of Operation	Continuous
<b>Medical Equipment</b>	
 	
Medical Device Directive:	Council Directive 93/42/EEC

## Chapter 5: Technical Specification of The Belmont® Rapid Infuser RI-2

Symbols and Definitions	
Symbol	Description
	Compliance to Medical Device Directive 93/42/EEC and 2011/65/EU
	Alternating current
	Equipotentiality
	OFF
	ON
	Caution
	For use by physician prescription only
	MR Unsafe
 or 	Consult accompanying documents / refer to manual
	Defibrillator-proof type CF equipment
IPX2	Protected against dripping water
SN	Serial Number
	Manufactured by

## Chapter 5: Technical Specification of The Belmont® Rapid Infuser RI-2

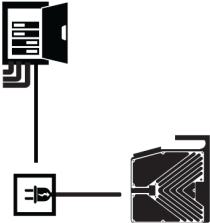
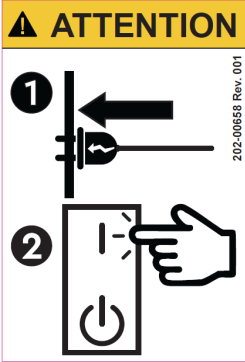
	<p>Authorized European Representative</p>
	<p>Waste Electrical and Electronic Equipment</p>
	<p>Use Dedicated Circuit Breaker</p>
	<p>Plug system into AC power prior to powering on</p>

### Waste Electrical and Electronic Equipment (WEEE)

The crossed-out wheel bin symbol on the product, literature, or packaging reminds you that all electrical and electronic products, batteries, and accumulators must be taken to separate collection at the end of their working life. This requirement applies to the European Union and other locations where separate collection systems are available. To prevent possible harm to the environment or human health from uncontrolled waste disposal, please do not dispose of these products as unsorted municipal waste, but instead, hand in at an official collection point for recycling.